

ULTRA 11k Hybrid User Manual

Table of Contents

ABOUT THIS MANUAL	1
Purpose.....	1
Scope.....	1
SAFETY INSTRUCTIONS.....	1
INTRODUCTION	2
Features	2
Basic System Architecture	2
Product Overview.....	3
Unpacking and Inspection	4
Preparation	4
Mounting the Unit.....	4
Battery Connection	5
AC Input/Output Connection	6
PV Connection	8
Final Assembly	9
Communication Connection.....	10
Dry Contact Signal and RSD Control.....	11
OPERATION.....	12
Power ON/OFF	12
Operation and Display Panel	12
Pages Information.....	13
LCD Setting.....	14
Warning and Fault List	18
CLEARANCE AND MAINTENANCE FOR ANTI-DUST KIT	19
Overview	19
Clearance and Maintenance	19
BATTERY EQUALIZATION	20
SPECIFICATIONS	21
Table 1 Line Mode Specifications	21
Table 2 Inverter Mode Specifications	22
Table 3 Charge Mode Specifications.....	23
Table 4 General Specifications.....	23
TROUBLE SHOOTING	25
Appendix I: Parallel function	27
Appendix II: BMS Communication Installation.....	37
Appendix III: The Wi-Fi Operation Guide.....	40
Appendix IV: The CT Operation Guide	50

ABOUT THIS MANUAL

Purpose

This manual describes the assembly, installation, operation and troubleshooting of this unit. Please read this manual carefully before installations and operations. Keep this manual for future reference.

Scope

This manual provides safety and installation guidelines as well as information on tools and wiring.

SAFETY INSTRUCTIONS

⚠ WARNING: This chapter contains important safety and operating instructions. Read and keep this manual for future reference.

1. Before using the unit, read all instructions and cautionary markings on the unit, the batteries and all appropriate sections of this manual.
2. **CAUTION** – To reduce risk of injury, charge only deep-cycle lead acid type rechargeable batteries. Other types of batteries may burst, causing personal injury and damage.
3. Do not disassemble the unit. Take it to a qualified service center when service or repair is required. Incorrect re-assembly may result in a risk of electric shock or fire.
4. To reduce risk of electric shock, disconnect all wirings before attempting any maintenance or cleaning. Turning off the unit will not reduce this risk.
5. **CAUTION** – Only qualified personnel can install this device with battery.
6. **NEVER** charge a frozen battery.
7. For optimum operation of this inverter/charger, please follow required spec to select appropriate cable size. It's very important to correctly operate this inverter/charger.
8. Be very cautious when working with metal tools on or around batteries. A potential risk exists to drop a tool to spark or short circuit batteries or other electrical parts and could cause an explosion.
9. Please strictly follow installation procedure when you want to disconnect AC or DC terminals. Please refer to INSTALLATION section of this manual for the details.
10. Fuses are provided as over-current protection for the battery supply.
11. GROUNDING INSTRUCTIONS -This inverter/charger should be connected to a permanent grounded wiring system. Be sure to comply with local requirements and regulations to install this inverter.
12. NEVER cause AC output and DC input short-circuited. Do NOT connect to the mains when DC input short circuits.
13. **Warning!!** Only qualified service persons are able to service this device. If errors still persist after following troubleshooting table, please send this inverter/charger back to local dealer or service center for maintenance.
14. **WARNING:** Because this inverter is non-isolated, only three types of PV modules are acceptable: single crystalline, poly crystalline with class A-rated and CIGS modules. To avoid any malfunction, do not connect any PV modules with possible current leakage to the inverter. For example, grounded PV modules will cause current leakage to the inverter. When using CIGS modules, please be sure NO grounding.
15. **CAUTION:** It's required to use PV junction box with surge protection. Otherwise, it will cause damage on inverter when lightning occurs on PV modules.

INTRODUCTION

This is a multi-function inverter, combining functions of inverter, solar charger and battery charger to offer uninterruptible power support in a single package. The comprehensive LCD display offers user-configurable and easy-accessible button operations such as battery charging current, AC or solar charging priority, and acceptable input voltage based on different applications.

Features

- Pure sine wave inverter
- Built-in LED bars to indicate the energy source and power flow
- Touchable button with seven-page colorful LCD
- Built-in Wi-Fi for mobile monitoring and OTA firmware upgrade (APP is required)
- Supports USB On-the-Go function
- Built-in current transformer sensor to meet self-consumption application
- Dual outputs for smart load management
- Two independent AC power sources connected and switched automatically
- Configurable output usage timer and prioritization
- Configurable charger source priority
- Configurable battery charging current
- Reserved communication ports for BMS (RS485, CAN-BUS)
- Reserved external BTS (Battery Temperature Sensor) detection
- Reserved optional GFCI, Rapid shutdown, AFCI detections
- Built-in anti-dusk kit

Basic System Architecture

The following illustration shows basic application for this unit. It also required the following devices to have a complete running system:

- Generator or Utility mains.
- PV modules

Consult with your system integrator for other possible system architectures depending on your requirements.

This inverter can power various appliances in home or office environment, including motor-type appliances such as tube light, fan, refrigerator and air conditioners.

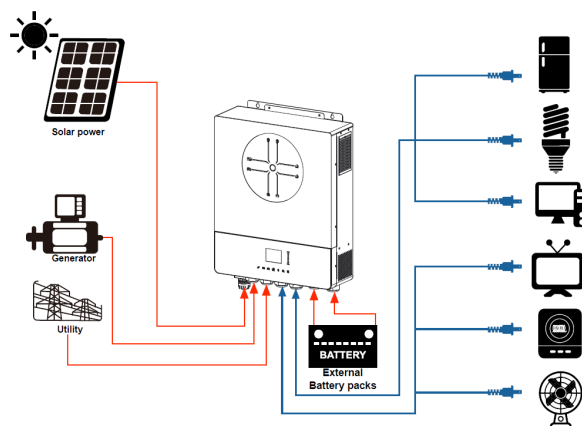
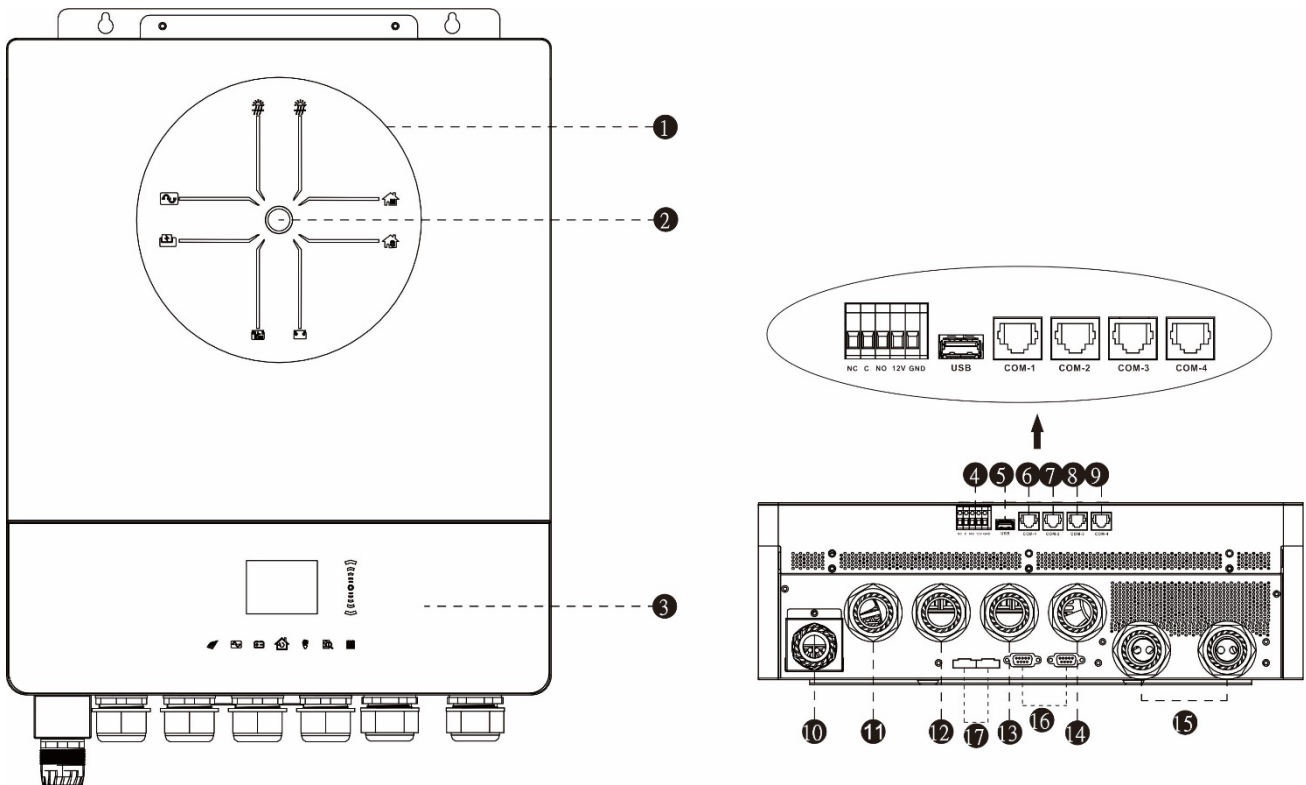

Figure 1 Basic hybrid PV System Overview

Product Overview



NOTE: For parallel installation and operation, please check *Appendix I*.

1. LED indicator bars
2. Power on switch
3. Touchpad function keys and LCD
4. Dry contact port and reserved rapid shutdown control port
5. Type A USB disk port
6. COM1: External BTS port
7. COM2: BMS port
8. COM3: RS232 port
9. COM4: Reserved GFCI, AFCI detection port
10. PV input 1 & 2
11. Generator input
12. Grid input
13. AC output 1
14. AC output 2
15. Battery input
16. Parallel communication port
17. Parallel current sharing port

INSTALLATION

Unpacking and Inspection

Before installation, please inspect the unit. Be sure that nothing inside the package is damaged. You should have received the following items inside of package:

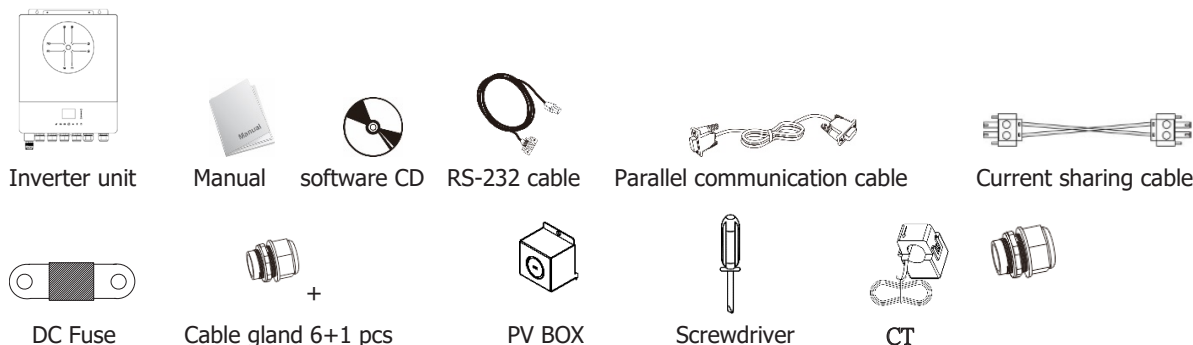

Preparation

Before connecting all wirings, please take off wiring cover by removing five screws. When removing the bottom cover, be carefully to remove two cables as shown below.

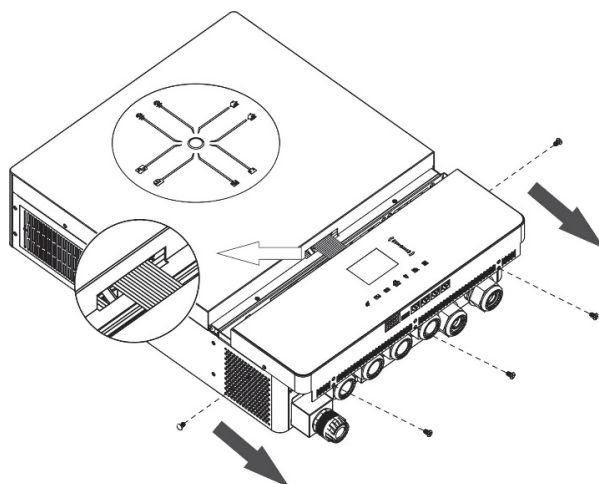

Mounting the Unit

Consider the following points before selecting where to install:

- Do not mount the inverter on flammable construction materials.
- Mount on a solid surface
- Install this inverter at eye level in order to allow the LCD display to be read at all times.
- The ambient temperature should be between 0°C and 55°C to ensure optimal operation.
- The recommended installation position is to be adhered to the wall vertically.
- Be sure to keep other objects and surfaces as shown in the right diagram to guarantee sufficient heat dissipation and to have enough space for removing wires.

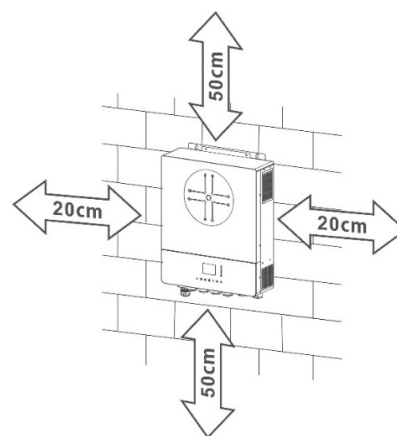

 **SUITABLE FOR MOUNTING ON CONCRETE OR OTHER NON-COMBUSTIBLE SURFACE ONLY.**

Install the unit by screwing four screws. It's recommended to use M4 or M5 screws.

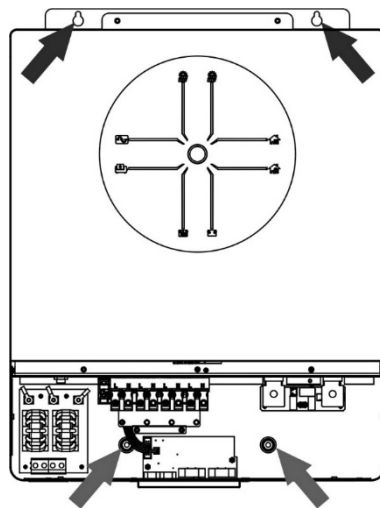

Battery Connection

CAUTION: For safety operation and regulation compliance, it's requested to install a separate DC over-current protector or disconnect device between battery and inverter. It may not be requested to have a disconnect device in some applications, however, it's still requested to have over-current protection installed. Please refer to typical amperage in below table as required fuse or breaker size.

WARNING! All wiring must be performed by a qualified personnel.

WARNING! It's very important for system safety and efficient operation to use appropriate cable for battery connection. To reduce risk of injury, please use the proper recommended cable and terminal size as below.

Ring terminal:

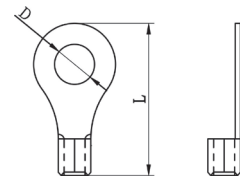

Recommended battery cable and terminal size:

Typical Amperage	Battery capacity	Wire Size	Cable mm ²	Ring Terminal Dimensions		Torque value
				D (mm)	L (mm)	
228A	250AH	1*4/0AWG	85	8.4	54	5 Nm

Please follow below steps to implement battery connection:

1. Assemble battery ring terminal based on recommended battery cable and terminal size.
2. Fix two cable glands into positive and negative terminals.
3. Insert the ring terminal of battery cable flatly into battery connector of inverter and make sure the nuts are tightened with torque of 5 Nm. Make sure polarity at both the battery and the inverter/charge is correctly connected and ring terminals are tightly screwed to the battery terminals.



WARNING: Shock Hazard

Installation must be performed with care due to high battery voltage in series.



CAUTION!! Do not place anything between the flat part of the inverter terminal and the ring terminal. Otherwise, overheating may occur.

CAUTION!! Do not apply anti-oxidant substance on the terminals before terminals are connected tightly.

CAUTION!! Before making the final DC connection or closing DC breaker/disconnector, be sure positive (+) must be connected to positive (+) and negative (-) must be connected to negative (-).

AC Input/Output Connection

CAUTION!! Before connecting to AC input power source, please install a **separate** AC breaker between inverter and AC input power source. This will ensure the inverter can be securely disconnected during maintenance and fully protected from over current of AC input.

CAUTION!! There are two terminal blocks with "IN" and "OUT" markings. Please do NOT mis-connect input and output connectors.

WARNING! All wiring must be performed by a qualified personnel.

WARNING! It's very important for system safety and efficient operation to use appropriate cable for AC input connection. To reduce risk of injury, please use the proper recommended cable size as below.

Suggested cable requirement for AC wires

Gauge	Torque Value
6 AWG	1.4~ 1.6Nm

Please follow below steps to implement AC input/output connection:

1. Before making AC input/output connection, be sure to open DC protector or disconnecter first.
2. Remove insulation sleeve 10mm for eight conductors. And shorten phase L and neutral conductor N 3mm
3. Install three cable glands on input and output sides.
4. Insert AC input wires according to polarities indicated on terminal block and tighten the terminal screws.

Be sure to connect PE protective conductor (⊕) first.

- ⊕ → **Ground (yellow-green)**
- L1 → **LINE (brown or black)**
- N1 → **Neutral (blue)**
- L2 → **Generator (brown or black)**
- N2 → **Neutral (blue)**

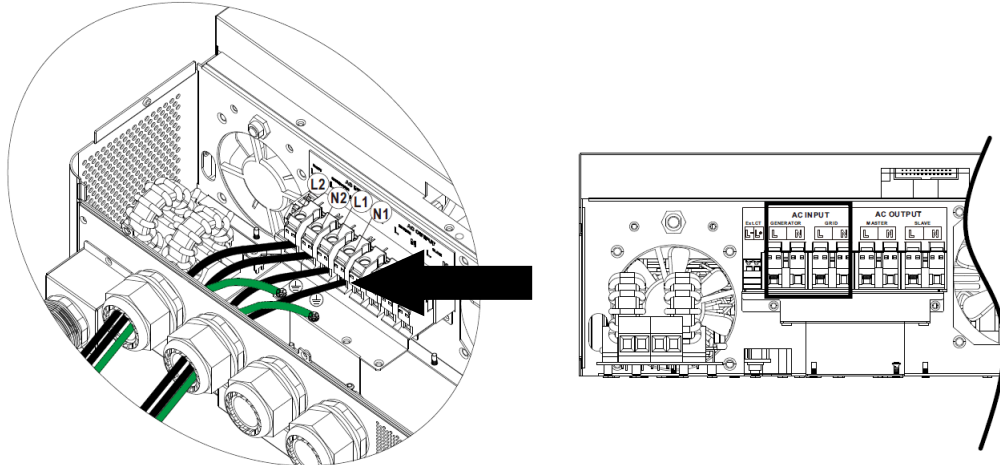

WARNING:

Be sure that AC power source is disconnected before attempting to hardwire it to the unit.

5. Then, insert AC output wires according to polarities indicated on terminal block and tighten terminal screws. Be sure to connect PE protective conductor (⊕) first.

- ⊕ → **Ground (yellow-green)**
- L1 → **LINE (brown or black)**
- N1 → **Neutral (blue)**
- L2 → **LINE (brown or black)**
- N2 → **Neutral (blue)**

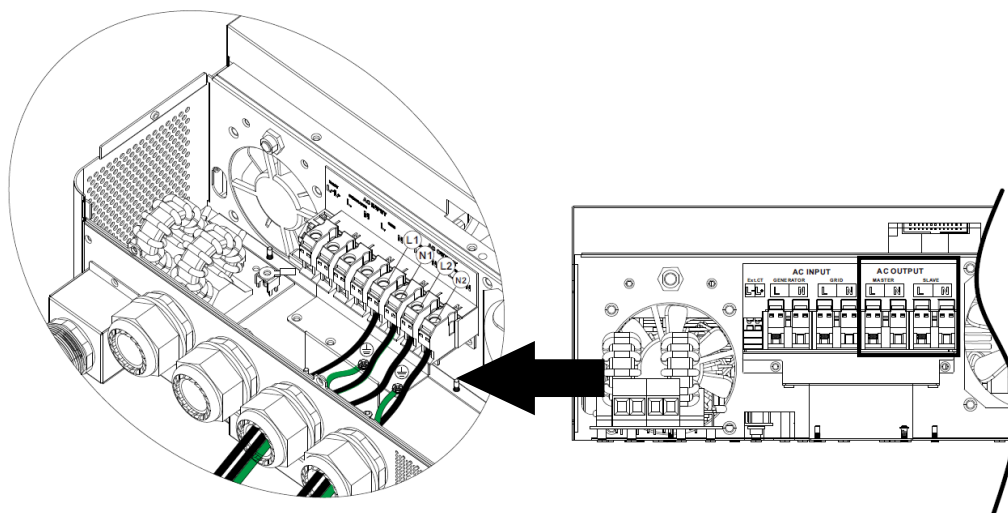

6. Make sure the wires are securely connected.

CAUTION: Important

Be sure to connect AC wires with correct polarity. If L and N wires are connected reversely, it may cause utility short-circuited when these inverters are worked in parallel operation.

CAUTION: Appliances such as air conditioner requires at least 2~3 minutes to restart because it's required to have enough time to balance refrigerant gas inside of circuits. If a power shortage occurs and recovers in a short time, it will cause damage to your connected appliances. To prevent this kind of damage, please check manufacturer of air conditioner if it's equipped with time-delay function before installation. Otherwise, this inverter/charger will be trigger overload fault and cut off output to protect your appliance but sometimes it still causes internal damage to the air conditioner.

PV Connection

CAUTION: Before connecting to PV modules, please install **separately** DC circuit breakers between inverter and PV modules.

NOTE1: Please use 600VDC/30A circuit breaker on each PV input.

NOTE2: The overvoltage category of the PV input is II.

Please follow the steps below to implement PV module connection:

WARNING: Because this inverter is non-isolated, only three types of PV modules are acceptable: single crystalline and poly crystalline with class A-rated and CIGS modules.

To avoid any malfunction, do not connect any PV modules with possible current leakage to the inverter. For example, grounded PV modules will cause current leakage to the inverter. When using CIGS modules, please be sure NO grounding.

CAUTION: It's required to use PV junction box with surge protection. Otherwise, it will cause damage on inverter when lightning occurs on PV modules.

Step 1: Remove the cover plate from the PV input port

CAUTION: Keep the cover plate installed if system do not configure with PV panels.

CAUTION: Exceeding the maximum input voltage can destroy the unit!! Check the system before wire connection.

Step 2: Install GLAND BUSHING on the PV BOX first and assemble it on the system

Step 3: Confirm the positive and negative marks on the terminal to avoid wrong installation

Prepare the cable and follow the connector assembly process:

Strip one cable 8 mm on both end sides and be careful NOT to nick conductors.

I

Step 4: Check correct polarity of connection cable from PV modules and PV input connectors. Then, connect positive pole (+) of connection cable to positive pole (+) of PV input connector. Connect negative pole (-) of connection cable to negative pole (-) of PV input connector.

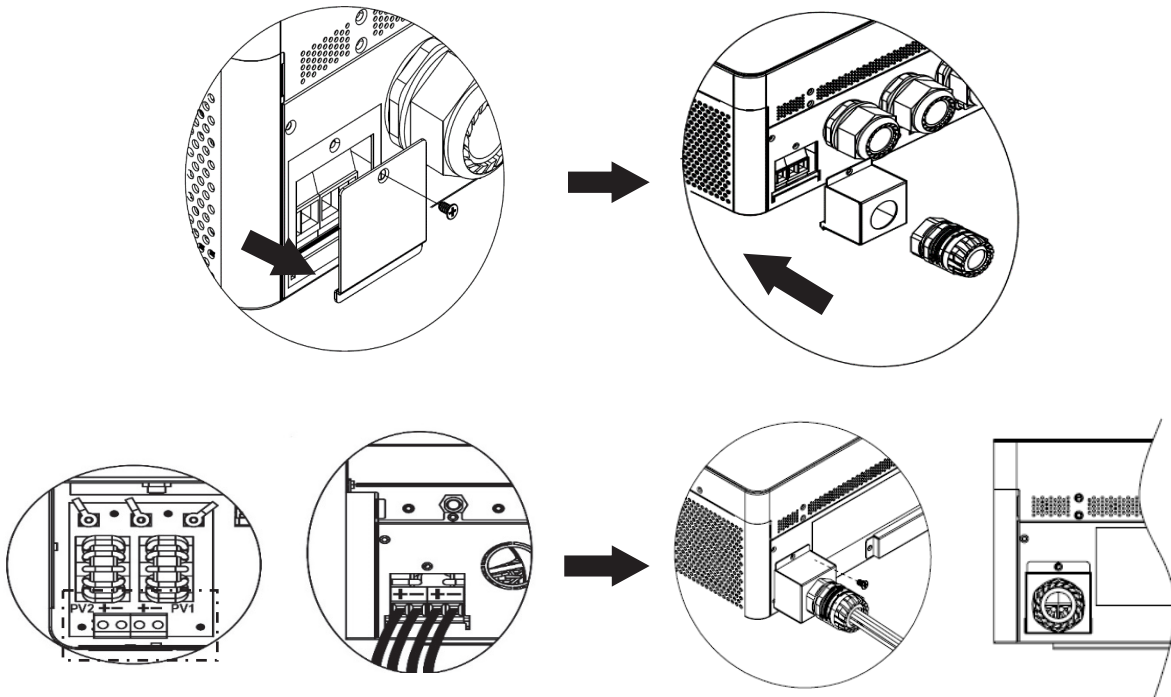

WARNING! For safety and efficiency, it's very important to use appropriate cables for PV module connection. To reduce risk of injury, please use the proper cable size as recommended below.

Conductor cross-section (mm ²)	AWG no.
4~6	10~12

Recommended Panel Configuration

When selecting proper PV modules, please be sure to consider the following parameters:

1. Open circuit Voltage (Voc) of PV modules not to exceed maximum PV array open circuit voltage of the inverter.
2. Open circuit Voltage (Voc) of PV modules should be higher than the start-up voltage.

Max. PV Array Power	12000W
Max. PV Array Open Circuit Voltage	500Vdc
PV Array MPPT Voltage Range	90Vdc~450Vdc
Start-up Voltage (Voc)	80Vdc

Recommended solar panel configuration:

Take the 555Wp PV module as an example. After considering above two parameters, the recommended module configurations are listed in the table below.

Solar Panel Spec. (reference) - 555Wp - Imp: 17.32A - Voc: 38.46Vdc - Isc: 18.33A - Cells: 110	SOLAR INPUT 1	SOLAR INPUT 2	Q'ty of panels	Total Input Power
	Min in series: 3pcs, per input			
	Max. in series: 11pcs, per input			
	3pcs in series	x	3pcs	1665W
	x	3pcs in series	3pcs	1665W
	7pcs in series	x	7pcs	3885W
	x	7pcs in series	7pcs	3885W
	10pcs in series	x	10pcs	5550W
	x	10pcs in series	10pcs	5550W
	7pcs in series	7pcs in series	14pcs	7770W
	11pcs in series	11pcs in series	22pcs	12210W

Final Assembly

After connecting all wirings, re-connect one cables and then put bottom cover back by fixing five screws as shown below.

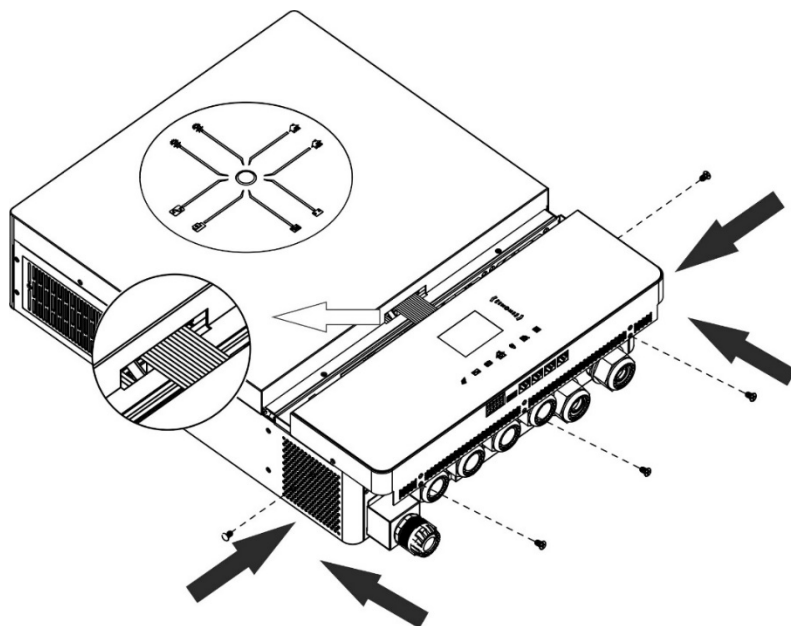

Communication Connection

Wi-Fi Connection

This unit is equipped with a Wi-Fi transmitter. Wi-Fi transmitter can enable wireless communication between solar inverters and monitoring platform. Users can access and control the monitored inverter with downloaded APP. You may find "i.Solar" app from the Apple® Store or Google® Play Store. All data loggers and parameters are saved in iCloud. For quick installation and operation, please check Appendix III.

Serial Connection (COM1)

This port is reserved to connect an external battery temperature sensor to compensate the charging parameter to optimize the battery lifecycle. For detailed information, please check with your installer to get the specification of the optional battery temperature sensor.

BMS Communication Connection (COM2)

It is recommended to purchase a special communication cable if you are connecting to Lithium-Ion battery modules. Please refer to Appendix II - BMS Communication Installation for details.

Serial Connection (COM3)

Please use the supplied serial cable to connect between the inverter and your PC. Install the monitoring software from the bundled CD and follow the on-screen instructions to complete your installation. For detailed software operation, refer to the software user manual on the bundled CD.

Serial Connection (COM4)

This port is reserved to allow the external GFCI or AFCI devices to be integrated to enhance the protection of solar inverter system. For detailed information, please check with your installer to get the specification of required GFCI and AFCI devices.

Dry Contact Signal and RSD Control

There is one dry contact (3A/250VAC) signal available on the terminal block. It could be used to deliver signal to external device when battery voltage reaches warning level.

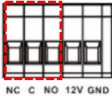
Unit Status	Condition				
				NC & C	NO & C
Power Off	Unit is off and no output is powered.			Close	Open
Power On	Output is powered from Battery power or Solar energy.	Output source priority set as USB (utility first) or SUB (solar first)	Battery voltage < Low DC warning voltage	Open	Close
			Battery voltage > Setting value in restart charge or battery charging reaches floating stage	Close	Open
		Output source priority is set as SBU (SBU priority)	Battery voltage < Setting value stop discharge	Open	Close
			Battery voltage > Setting value in restart charge or battery charging reaches floating stage	Close	Open

There is another output control port available on the terminal block. It is reserved to allow an external RSD (Rapid Shutdown Device) to be integrated into this solar inverter system to cut off energy from PV arrays in case of any emergency conditions. For detailed RSD specification, please check with your installer.

External RSD control	
----------------------	---

OPERATION

Power ON/OFF

Once the unit is properly installed and the batteries are connected well, simply press power switch to turn on the unit.

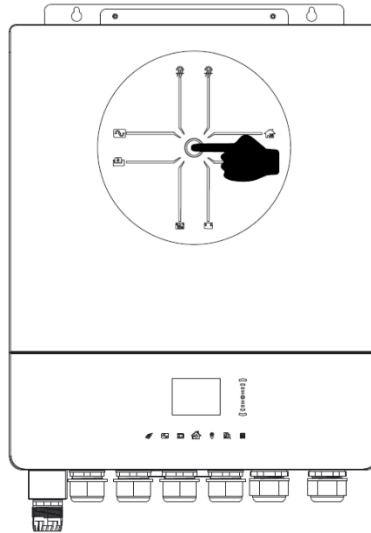

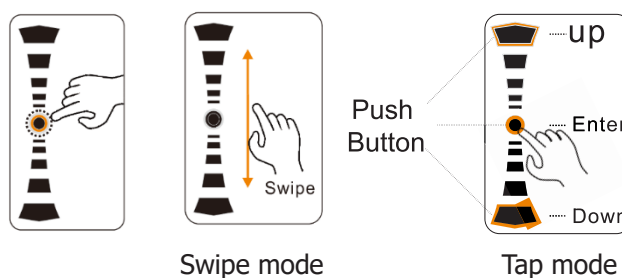
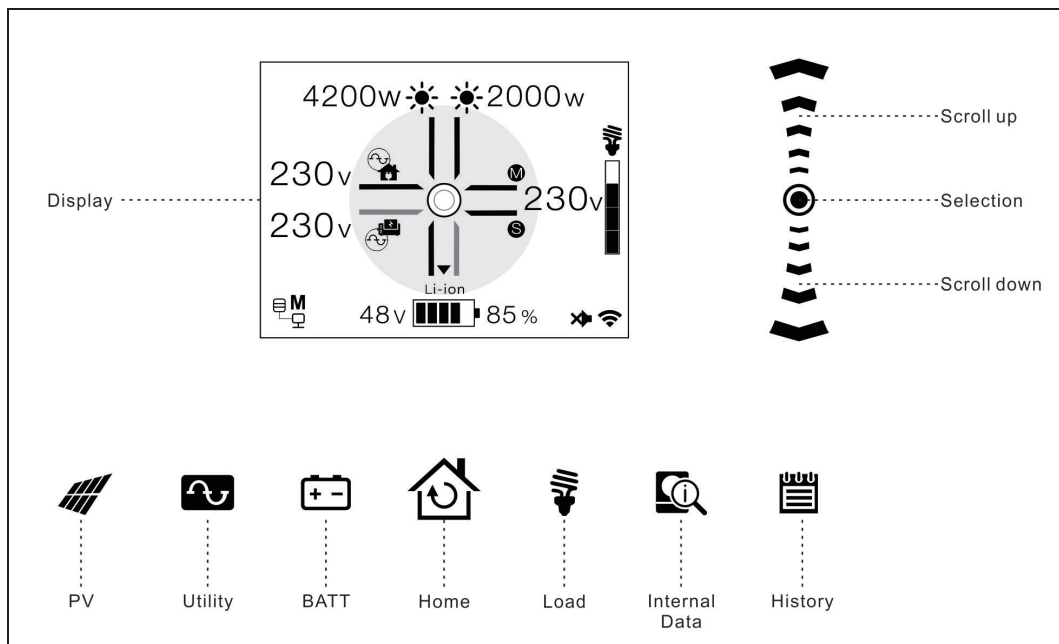

Operation and Display Panel

The operation and display panel, shown in below chart, is located on the top of the unit. It includes seven-page colorful LCD display, scrollbar/Tap and graphic touch pads, indicating the operating status and input/output power information.



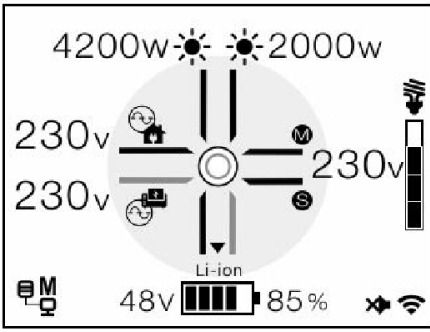
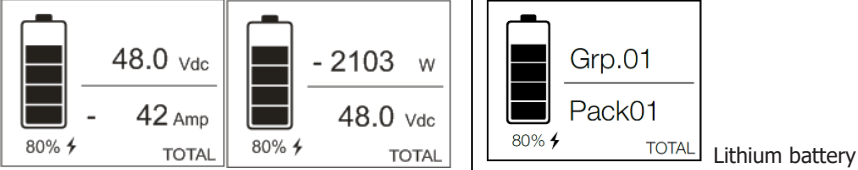
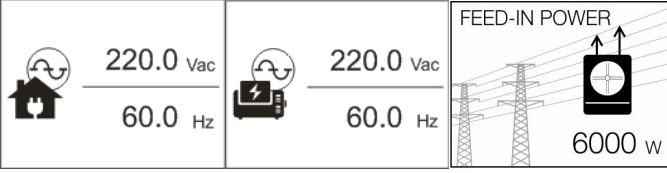
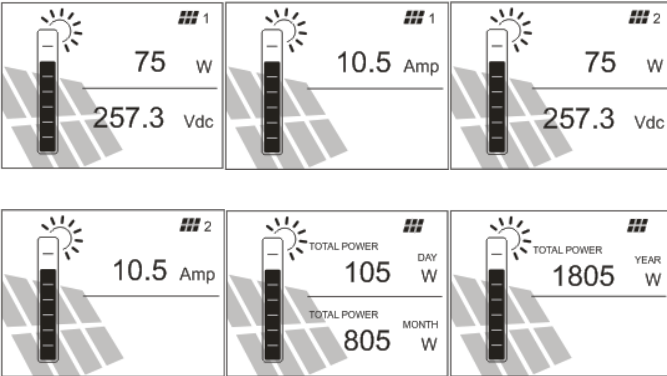
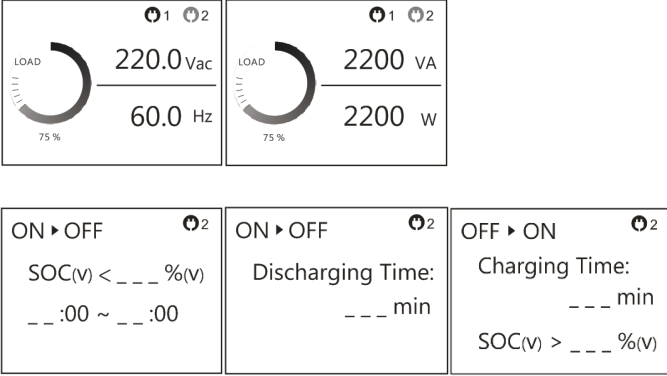
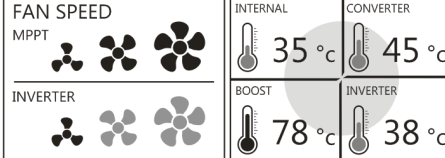

Pages Information

When the unit is turned on, the LCD display will show home page after few seconds.

<p>Home page: (tap  icon 0.5s)</p> <p>indicates the summarized power flow and energy information.</p> 	
<p>Battery page: Indicates the battery information.</p>	
<p>AC input page: Indicates the dual AC input information.</p>	
<p>PV page: Indicates the PV information.</p>	
<p>AC output page: Indicates the AC output information.</p>	
<p>Internal data page: Indicates fan speed and temperature information.</p>	







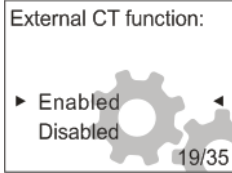

<p>Logs page: Indicates all event, warning, and fault messages.</p>	<div style="border: 1px solid black; padding: 5px;"> <p style="text-align: right;">1/15</p> <p>02-02, 18:30 W01 Grid not exist.</p>  </div>
---	--

LCD Setting

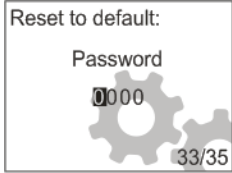
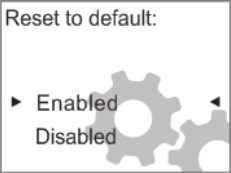
<p>Press  icon for 3s to enter the setting menu.</p> <p>There are three sub-menus: Information, Basic and Advanced.</p> <p>Click  icon again to exit setting and return to Home page.</p>		<div style="border: 1px solid gray; padding: 5px; text-align: center;"> <p>SETTING</p> <p>ADVANCED</p> <p>▶ BASIC ◀</p> <p>INFORMATION</p> </div>	
Information			
<div style="border: 1px solid gray; padding: 5px;"> <p>Information:</p> <p>S/N : xxxxxxxxxxxx HW : xxxxx DSP: xxxxx</p> <p style="text-align: right;">1/2</p> </div>		<div style="border: 1px solid gray; padding: 5px;"> <p>Information:</p> <p>MCU 1 : xxxxx MCU 2 : xxxxx LCD : xxxxx</p> <p style="text-align: right;">2/2</p> </div>	
Basic			
<p>Change the main page</p> <div style="border: 1px solid gray; padding: 5px; margin: 0 auto; width: 100px;"> <p>SETTING</p> <p>ADVANCED</p> <p>▶ BASIC ◀</p> <p>INFORMATION</p> </div>			
<p style="text-align: center;">Setup home page</p> <div style="border: 1px solid gray; padding: 5px;"> <p>Home page:</p> <p>SOLAR</p> <p>▶ HOME ◀</p> <p>INPUT</p> <p style="text-align: right;">1/10</p> </div>	<p style="text-align: center;">Turn on/off Wi-Fi module</p> <div style="border: 1px solid gray; padding: 5px;"> <p>Wi-Fi:</p> <p>▶ Enabled ◀</p> <p>Disabled</p> <p style="text-align: right;">2/10</p> </div>	<p style="text-align: center;">Turn on/off buzzer</p> <div style="border: 1px solid gray; padding: 5px;"> <p>Mute:</p> <p>▶ Enabled ◀</p> <p>Disabled</p> <p style="text-align: right;">3/10</p> </div>	<p style="text-align: center;">Setup date</p> <div style="border: 1px solid gray; padding: 5px;"> <p>Date:</p> <p>2023-10-10</p> <p style="text-align: right;">4/10</p> </div>
<p style="text-align: center;">Setup time</p> <div style="border: 1px solid gray; padding: 5px;"> <p>Time:</p> <p>14:25:30</p> <p style="text-align: right;">5/10</p> </div>	<p style="text-align: center;">Setup log record duration</p> <div style="border: 1px solid gray; padding: 5px;"> <p>Data log stored period:</p> <p>1 Week</p> <p>▶ 2 Weeks ◀</p> <p>3 Weeks</p> <p style="text-align: right;">6/10</p> </div>	<p style="text-align: center;">Enable screen off timer</p> <div style="border: 1px solid gray; padding: 5px;"> <p>Screen Off:</p> <p>Disabled</p> <p>▶ 3 Min. ◀</p> <p>5 Min.</p> <p style="text-align: right;">7/10</p> </div>	<p style="text-align: center;">Change RGB LED color</p> <div style="border: 1px solid gray; padding: 5px;"> <p>RGB Color:</p> <p>▶ [Color Selection] ◀</p> <p style="text-align: right;">8/10</p> </div>
<p style="text-align: center;">Setup LED Bar mode</p> <div style="border: 1px solid gray; padding: 5px;"> <p>LED Bar:</p> <p>▶ V1 ◀</p> <p>V2</p> <p style="text-align: right;">9/10</p> </div> <p>V1: The Grid of LED lighting bar with running effect. V2: LED lighting bar is illuminated. Default: V1</p>		<p style="text-align: center;">Setup Touch Pad mode</p> <div style="border: 1px solid gray; padding: 5px;"> <p>Touch Pad:</p> <p>▶ V1 ◀</p> <p>V2</p> <p style="text-align: right;">10/10</p> </div> <p>V1: Touch pad is setup as swipe mode. V2: Touch pad is setup as tap mode. Default: V1</p>	

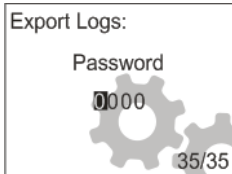
Advanced		
<p>Configure the nominal voltage and frequency</p> <p>Default: 230Vac, 50Hz</p>	<p>Inverter Volt:</p> <p>220Vac ▶ 230Vac 240Vac</p> <p>1/35</p>	<p>Inverter Frequency:</p> <p>▶ 60 Hz 50 Hz</p> <p>2/35</p>
<p>Configure the output and charger source priority</p> <p>Regular: Priority arranged every day Schedule: Priority arranged during setting hours If setting 00hr – 00hr, the setting will not be activated.</p> <p>Default: Regular</p>	<p>Output Source Priority:</p> <p>▶ Schedule Regular</p> <p>3/35</p> <p>Output Source Priority: [Regular] USB ▶ SUB SBU</p> <p>Output Source Priority: [Schedule] USB ▶ SUB SBU</p> <p>Output Source Priority: [SUB] 09hr ~ 18hr</p>	<p>Charger Source Priority:</p> <p>▶ Schedule Regular</p> <p>4/35</p> <p>Charger Source Priority: [Regular] Solar ▶ Utility+Solar Solar only</p> <p>Charger Source Priority: [Schedule] Solar ▶ Utility+Solar Solar only</p> <p>Charger Source Priority: [Utility+Solar] 09hr ~ 18hr</p>
<p>Battery Type</p> <p>If "User-Defined" is selected, battery charge voltage and minimum voltage can be set up.</p> <p>If any lithium battery type is selected, maximum charging current, CV and floating voltage will be automatically set up. No need for further setting.</p> <p>Default: AGM</p>	<p>Battery type:</p> <p>Flooded ▶ User-Defined Pylontech battery</p> <p>5/35</p>	<p>Battery type:</p> <p>Pylontech battery ▶ WECO battery Soltaro battery</p> <p>5/35</p>
	<p>Battery type:</p> <p>Soltaro battery ▶ LIB LIC</p> <p>5/35</p>	<p>Battery type:</p> <p>LIC ▶ AGM Flooded</p> <p>5/35</p>
<p>Configure the stop and restart discharging voltage/SOC and minimum voltage/SOC</p> <p>If any types of lithium battery is selected in battery type, setting value will change to SOC automatically.</p> <p>Default: 46V (Stop discharging Volt), 54V (Start re-discharging Volt), 44V (Minimum Vol Level).</p> <p>Default: 10% (Stop discharging SOC), 80% (Start re-discharging SOC), 10% (Minimum SOC Level)</p>	<p>Stop Discharging Volt:</p> <p>45.9 V ▶ 46.0 V 46.1 V</p> <p>6/35</p>	<p>Start Re-Discharging Volt:</p> <p>53.9 V ▶ 54.0 V 54.1 V</p> <p>7/35</p>
	<p>Stop Discharging SOC:</p> <p>▶ 5 % 10 % 15 %</p> <p>6/35</p>	<p>Start Re-Discharging SOC:</p> <p>▶ 70 % 80 % 90 %</p> <p>7/35</p>
		<p>Minimum Vol Level:</p> <p>43.9 V ▶ 44.0 V 44.1 V</p> <p>10/35</p>
		<p>Minimum SOC Level:</p> <p>▶ 0 % 10 % 20 %</p> <p>10/35</p>
<p>Configure the CV and floating voltage</p> <p>Default: 56.4V (Charging CV Volt), 54V (Charging Floating Volt)</p>	<p>Charging CV Volt:</p> <p>56.3 V ▶ 56.4 V 56.5 V</p> <p>8/35</p>	<p>Charging Floating Volt:</p> <p>53.9 V ▶ 54.0 V 54.1 V</p> <p>9/35</p>
<p>Configure the maximum charging current and limitation while charging from Utility and Generator</p> <p>Default: 60A (Max charging current), 30A (Generator charging current), 30A (AC charging current)</p>	<p>Max. Charging Current:</p> <p>10 A ▶ 20 A 30 A</p> <p>11/35</p>	<p>Generator Charging Current:</p> <p>2 A ▶ 10 A 20 A</p> <p>12/35</p>
		<p>Utility Charging Current:</p> <p>2 A ▶ 10 A 20 A</p> <p>13/35</p>
<p>Configure the max. discharging current</p> <p>Default: Disabled (no limitation)</p>	<p>Max. Discharge Current:</p> <p>Disabled ▶ 30 A 40 A</p> <p>14/35</p>	

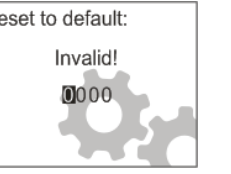
<p>Configure the compatibility of AC input source</p> <p>Default: Generator</p>	<p>AC Input Volt Range:</p> <p>Generator(Sensitive)</p> <p>► Utility ◀</p> <p>Generator</p> <p>15/35</p>
<p>Configure fault or overload behaviors</p> <p>Default: Disabled, Disabled</p>	<p>Fault Auto-restart:</p> <p>► Enabled ◀</p> <p>Disabled</p> <p>16/35</p> <p>Overload Bypass:</p> <p>► Enabled ◀</p> <p>Disabled</p> <p>17/35</p>
<p>Configure the compatibility of AC output mode</p> <p>Default: Single</p>	<p>AC Output Mode:</p> <p>L3 phase</p> <p>► Parallel ◀</p> <p>Single</p> <p>18/35</p>
<p>Configure battery equalization function, voltage, time, timeout, interval, activated immediately</p> <p>Default: Disable (battery EQ function), 58.4V (Battery EQ Volt), 60 min (Battery EQ time), 120 min, (Battery EQ timeout), 30 days (EQ interval), Disable (EQ immediately)</p>	<p>Battery EQ Function:</p> <p>► Enabled ◀</p> <p>Disabled</p> <p>20/35</p> <p>Battery EQ Volt:</p> <p>48.0 V</p> <p>► 48.1 V ◀</p> <p>48.2 V</p> <p>21/35</p> <p>Battery EQ time:</p> <p>55 min</p> <p>► 60 min ◀</p> <p>65 min</p> <p>22/35</p> <p>Batt EQ timeout:</p> <p>115 min</p> <p>► 120 min ◀</p> <p>125 min</p> <p>23/35</p> <p>EQ interval:</p> <p>29 days</p> <p>► 30 days ◀</p> <p>31 days</p> <p>24/35</p> <p>EQ Immediately:</p> <p>► Enabled ◀</p> <p>Disabled</p> <p>25/35</p>
<p>Configure cut-off voltage point or SOC and restart voltage or SOC on the second output (L2). If any types of lithium battery is selected in battery type, the setting value will change to SOC automatically.</p> <p>Default: 42V (discharge volt on the L2 output), 46V (Re-discharging volt on the L2 output)</p> <p>Default: 0% (discharge SOC on the L2 output), 20% (Re-discharging SOC on the L2 output)</p>	<p>Discharge Volt O/P-2:</p> <p>60.0 V</p> <p>► 42.0 V ◀</p> <p>42.1 V</p> <p>26/35</p> <p>Re-Discharge Volt O/P-2:</p> <p>61.0 V</p> <p>► 43.0 V ◀</p> <p>43.1 V</p> <p>29/35</p> <p>Discharge SOC O/P-2:</p> <p>55 %</p> <p>► 60 % ◀</p> <p>65 %</p> <p>Re-Discharge SOC O/P-2:</p> <p>55 %</p> <p>► 60 % ◀</p> <p>65 %</p>
<p>Configure discharge time to turn off second output (L2). And waiting time to turn on the second output (L2) when the inverter is back to Line Mode or battery is in charging status</p> <p>Default: Disable (Discharging Time on the L2 output), 0min (Re-discharging Time on the L2 output)</p>	<p>Discharge Time O/P-2:</p> <p>990 min</p> <p>► Disable ◀</p> <p>0 min</p> <p>28/35</p> <p>Re-Discharge Time O/P-2:</p> <p>990 min</p> <p>► 0 min ◀</p> <p>5 min</p> <p>30/35</p>
<p>Configure time interval to turn on the second output (L2)</p> <p>Default: 00hr~23hr</p>	<p>Discharge Interval O/P-2</p> <p>00hr ~ 23hr</p> <p>27/35</p>

<p>Configure external CT function</p> <p>Default: Disable</p>	<p>External CT function:</p> 
<p>Specific critical operations activate (It's necessary to enter Password 4743 to access)</p> <ul style="list-style-type: none"> - Reset to factory setting - Erase all logs - Export all logs - Firmware upgrade 	<div data-bbox="783 365 1015 537"> <p>Erase all data log:</p> <p>Password 0000</p>  </div> <div data-bbox="1031 365 1262 537"> <p>Erase all data log:</p> <p>▶ Not reset Reset</p>  </div> <div data-bbox="783 571 1015 743"> <p>Reset to default:</p> <p>Password 0000</p>  </div> <div data-bbox="1031 571 1262 743"> <p>Reset to default:</p> <p>▶ Enabled Disabled</p>  </div> <div data-bbox="783 777 1015 949"> <p>Firmware Upgrade:</p> <p>Password 0000</p>  </div> <div data-bbox="1031 777 1262 949"> <p>Firmware Upgrade:</p> <p>▶ NO YES</p>  </div> <div data-bbox="783 983 1015 1155"> <p>Export Logs:</p> <p>Password 0000</p>  </div> <div data-bbox="1031 983 1262 1155"> <p>Export Logs:</p> <p>▶ NO YES</p>  </div> <div data-bbox="783 1182 1262 1615"> <p>Invalid password, try again</p> <div data-bbox="783 1238 1015 1411"> <p>Erase all data log:</p> <p>Invalid! 0000</p>  </div> <div data-bbox="1031 1238 1262 1411"> <p>Reset to default:</p> <p>Invalid! 0000</p>  </div> <div data-bbox="783 1444 1015 1617"> <p>Firmware Upgrade:</p> <p>Invalid! 0000</p>  </div> <div data-bbox="1031 1444 1262 1617"> <p>Export Logs:</p> <p>Invalid! 0000</p>  </div> </div>

Warning and Fault List

Code Type	Code #	Event	Code Type	Code #	Event
Fault	F01	Fan fault	Fault	F17	High dc offset
Fault	F02	High PV-volt	Fault	F18	Over-load
Fault	F03	High bat-volt	Fault	F19	Amp sense fault
Fault	F04	Low bat-volt	Fault	F20	Backfeed fault
Fault	F05	Output S.C.	Fault	F21	Firmware fault
Fault	F06	High op-volt	Fault	F22	Par-CAN fault
Fault	F07	Low op-volt	Fault	F23	Par-host fault
Fault	F08	High bus-volt	Fault	F24	Par-sync fault
Fault	F09	Low bus-volt	Fault	F25	Par-bat fault
Fault	F10	High PV-amp	Fault	F26	Par-grid fault
Fault	F11	High inv-amp	Fault	F27	Par-opa fault
Fault	F12	High bus-amp	Fault	F28	Par-set fault
Fault	F13	High disc-amp	Fault	F29	OP Circuit Fault
Fault	F14	Over temp.	Fault	F30	PV-Iso Fault
Fault	F15	Bus start fault	Fault	F31	GFCI Fault
Fault	F16	Inv start fault	Fault	F32	AFD Fault

Warning	W01	Grid not exist	Warning	W11	Comm. Lost
Warning	W02	PV not exist	Warning	W12	Par limited
Warning	W03	Pack not exist	Warning	W13	Ip CB trip
Warning	W04	Weak SoC	Warning	W14	EQ warning
Warning	W05	Weak PV-volt	Warning	W15	MCU comm. lost
Warning	W06	Power de-rate	Warning	W16	Disable CHG& DISCHG
Warning	W07	Heavy load	Warning	W17	Disable CHG
Warning	W08	Temp issue	Warning	W18	Disable DISCHG
Warning	W09	Fan issue	Warning	W19	Force CHG
Warning	W10	BMS lost			

CLEARANCE AND MAINTENANCE FOR ANTI-DUST KIT

Overview

Every inverter is already installed with anti-dusk kit from factory. This kit keeps dusk from your inverter and increases product reliability in harsh environment.

Clearance and Maintenance

Step 1: Please remove the screws on the two sides of the inverter.

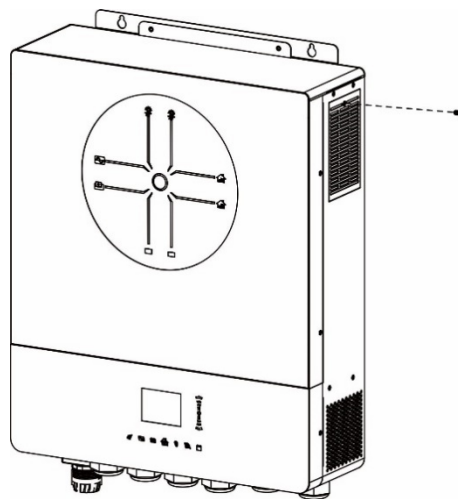

Step 2: Then, dustproof case can be removed and air filter foam can be taken out as shown in below chart.

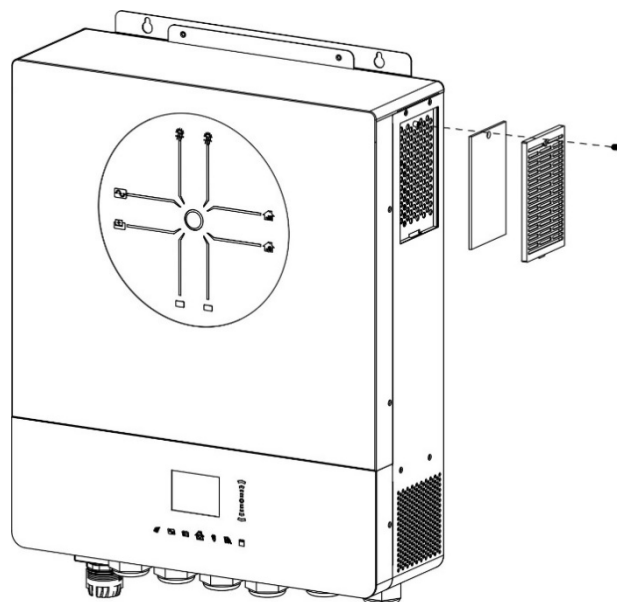

Step 3: Clean air filter foam and dustproof case. After clearance, re-assemble the dust-kit back to the inverter.

NOTICE: The anti-dust kit should be cleaned from dust every one month.

BATTERY EQUALIZATION

Equalization function is added into charge controller. It reverses the buildup of negative chemical effects like stratification, a condition where acid concentration is greater at the bottom of the battery than at the top. Equalization also helps to remove sulfate crystals that might have built up on the plates. If left unchecked, this condition, called sulfation, will reduce the overall capacity of the battery. Therefore, it's recommended to equalize battery periodically.

- **How to Apply Equalization Function**

You must enable battery equalization function in monitoring LCD setting Equalization function first. Then, you may apply this function in device by either one of following methods:

1. Setting equalization interval in LCD
2. Active equalization immediately in LCD

- **When to Equalize**

In float stage, when the setting equalization interval (battery equalization cycle) is arrived, or equalization is active immediately, the controller will start to enter Equalize stage.

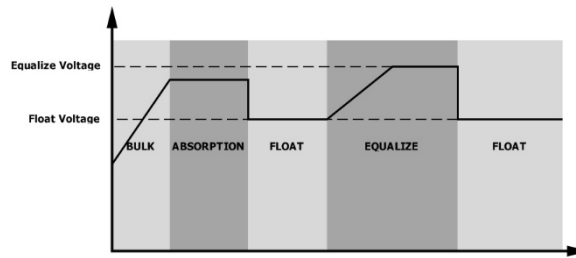

- **Equalize charging time and timeout**

In Equalize stage, the controller will supply power to charge battery as much as possible until battery voltage raises to battery equalization voltage. Then, constant-voltage regulation is applied to maintain battery voltage at the battery equalization voltage. The battery will remain in the Equalize stage until setting battery equalized time is arrived.

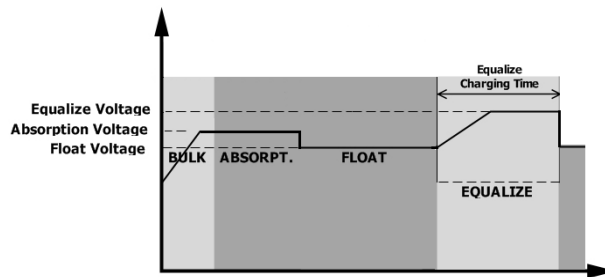

However, in Equalize stage, when battery equalized time is expired and battery voltage doesn't rise to battery equalization voltage point, the charge controller will extend the battery equalized time until battery voltage achieves battery equalization voltage. If battery voltage is still lower than battery equalization voltage when battery equalized timeout setting is over, the charge controller will stop equalization and return to float stage.

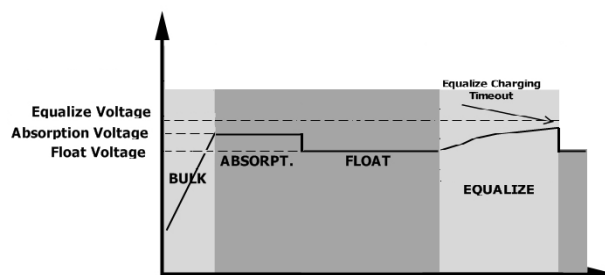

SPECIFICATIONS

Table 1 Line Mode Specifications

MODEL	11KW
Input Voltage Waveform	Sinusoidal (utility or generator)
Nominal Input Voltage	230Vac
Low Loss Voltage	170Vac±7V (utility) 90Vac±7V (generator)
Low Loss Return Voltage	180Vac±7V (utility); 100Vac±7V (generator)
High Loss Voltage	280Vac±7V
High Loss Return Voltage	270Vac±7V
Max AC Input Voltage	300Vac
Max AC Input Current	60A
Max 2nd Input Current	60A
Max 2nd Output Current	60A
Nominal Input Frequency	50Hz / 60Hz (Auto detection)
Low Loss Frequency	40±1Hz
Low Loss Return Frequency	42±1Hz
High Loss Frequency	65±1Hz
High Loss Return Frequency	63±1Hz
Output Short Circuit Protection	Line mode: Circuit Breaker (70A) Battery mode: Electronic Circuits
Efficiency (Line Mode)	>95% (Rated R load, battery full charged)
Transfer Time	10ms typical (UPS); 20ms typical (Appliances)
<p>Output power de-rating: When AC input voltage under 170V the output power will be de-rated.</p>	

Table 2 Inverter Mode Specifications

MODEL	11KW
Rated Output Power	11000W
Output Voltage Waveform	Pure Sine Wave
Output Voltage Regulation	230Vac±5%
Output Frequency	60Hz or 50Hz
Peak Efficiency	93%
Overload Protection	100ms@≥180% load;5s@≥120% load; 10s@105%~120% load
Surge Capacity	2* rated power for 5 seconds
Low DC Warning Voltage @ load < 20% @ 20% ≤ load < 50% @ load ≥ 50%	46.0Vdc 42.8Vdc 40.4Vdc
Low DC Warning Return Voltage @ load < 20% @ 20% ≤ load < 50% @ load ≥ 50%	48.0Vdc 44.8Vdc 42.4Vdc
Low DC Cut-off Voltage @ load < 20% @ 20% ≤ load < 50% @ load ≥ 50%	44.0Vdc 40.8Vdc 38.4Vdc
High DC Recovery Voltage	61Vdc
High DC Cut-off Voltage	63Vdc
DC Voltage Accuracy	+/-0.3V@ no load
THDV	<5% for linear load,<10% for non-linear load @ nominal voltage
DC Offset	≤100mV
Power Limitation When battery voltage is lower than 55Vdc, output power will be derated. If connected load is higher than this derated power, the AC output voltage will decrease until the output power reduces to this derated power. The minimum AC output voltage is output voltage setting – 10V.	

Table 3 Charge Mode Specifications

Utility Charging Mode		
MODEL		11KW
Charging Current (UPS) @ Nominal Input Voltage		150A
Bulk Charging Voltage	Flooded Battery	58.4Vdc
	AGM / Gel Battery	56.4Vdc
Floating Charging Voltage		54Vdc
Overcharge Protection		63Vdc
Charging Algorithm		3-Step
Charging Curve	<p>The graph shows Battery Voltage (per cell) on the left y-axis and Charging Current (%) on the right y-axis against Time on the x-axis. The voltage curve (black) rises linearly in the Bulk phase, plateaus in the Absorption phase, and then slightly drops in the Maintenance phase. The current curve (red) is constant in the Bulk phase, drops to a lower level in the Absorption phase, and continues to decrease in the Maintenance phase. Key voltage points are 2.43Vdc (2.35Vdc) and 2.25Vdc. Time intervals T0 and T1 are marked. A note indicates 'minimum 10mins, maximum 6hrs' for the Absorption phase.</p>	
Solar Input		
MODEL		11KW
Rated Power		12000W
Max. PV Array Open Circuit Voltage		500Vdc
PV Array MPPT Voltage Range		90Vdc~450Vdc
Max. Input Current		27A x 2(MAX 40A)
Max. Charging Current		150A
Start-up Voltage		80V +/- 5Vdc
Power Limitation	<p>The graph plots PV Current on the y-axis against MPPT Temperature on the x-axis. The current is constant at 27A from 0°C to 70°C. At 70°C, the current drops to 13.5A and remains constant up to 80°C.</p>	

Table 4 General Specifications

MODEL	11KW
Safety Certification	CE
Operating Temperature Range	-10°C to 50°C
Storage temperature	-15°C~ 60°C
Humidity	5% to 95% Relative Humidity (Non-condensing)
Dimension (D*W*H), mm	147.4x 440 x 553.6
Net Weight, kg	19.5

Table 5 Parallel Specifications

Max parallel numbers	6
Circulation Current under No Load Condition	Max 2A
Power Unbalance Ratio	<5% @ 100% Load
Parallel communication	CAN
Transfer time in parallel mode	Max 50ms
Parallel Kit	YES

Note: Parallel feature will be disabled when only PV power is available.

TROUBLE SHOOTING

Phenomenon and/or Possible cause	What to do
No response while press the main switch.	
No Utility power and PV is applied.	Check whether the DC breaker tripped or has not yet turned on? If problem still exists, please contact the service center to repair it.
No response while pressing the main switch.	
Utility power or PV power exists.	Check whether the AC breaker tripped? Or PV voltage reaches to the operation level? If problem still exists, please contact the service center to repair it.
Output turned off, Buzzer beeps continuously, RED LED solid on	
F01 shows. Fans abnormal stopped during startup sequence	Please contact service center to replace them.
F02 shows.	Configure the PV panels lower than 450V.
F03 shows.	Disconnect the Utility and PV power. Then, re-apply again. If over-voltage alarm still sounds, the internal charger might has some problem. Please contact with service center to repair it.
F05 shows.	Check and verify if there is any load with short circuit condition? Remove the load and restart the unit again. If problem still exists, please contact the service center to repair it.
F14 shows.	Clean the anti-dust filter and keep the unit installed in a well ventilated environment.
F18 shows.	Reduce the applied load and restart the unit again.
F06, F07, F08, F09, F10, F11, F12, F13, F15, F16, F17, F19 or F20 shows.	Please restart the unit again. If problem still exists, please contact the service center to repair it.
F20 shows.	<ol style="list-style-type: none"> Restart the inverter. Check if L/N cables are not connected reversely in all inverters. For parallel system in single phase, make sure the sharing are connected in all inverters. For supporting three-phase system, make sure the sharing cables are connected in the inverters in the same phase, and disconnected in the inverters in different phases. If the problem remains, please contact your installer.
F22, F23, or F24 shows.	<ol style="list-style-type: none"> Check if communication cables are connected well and restart the inverter. If the problem remains, please contact your installer.
F25 shows.	<ol style="list-style-type: none"> Make sure all inverters share same groups of batteries together. Remove all loads and disconnect AC input and PV input. Then, check battery voltage of all inverters. If the values from all inverters are close, please check if all battery cables are the same length and same material type. Otherwise, please contact your installer to provide SOP to calibrate battery voltage of each inverter.

	If the problem still remains, please contact your installer.
F26 shows.	<ol style="list-style-type: none"> 1. Check the utility wiring connection and restart the inverter. 2. Make sure utility starts up at same time. If there are breakers installed between utility and inverters, please be sure all breakers can be turned on AC input at same time. <p>If the problem remains, please contact your installer.</p>
F27 shows.	<ol style="list-style-type: none"> 1. Restart the inverter. 2. Remove some excessive loads and re-check load information from LCD of inverters. If the values are different, please check if AC input and output cables are in the same length and material type. <p>If the problem remains, please contact your installer.</p>
F28 shows.	<ol style="list-style-type: none"> 1. Switch off the inverter and check LCD setting AC output mode 2. For parallel system in single phase, make sure no 3P1, 3P2 or 3P3 is set. For supporting three-phase system, make sure no "PAL" is set on AC output mode setting 3. If the problem remains, please contact your installer.
F29 shows.	<ol style="list-style-type: none"> 1. Check if sharing cables are connected well and restart the inverter. 2. If the problem remains, please contact your installer.
Output powered but buzzer beeps per second, RED LED flashing	
W07 shows.	Reduce load will release the warning.
W08 shows.	Clean the anti-dust filter and keep the unit installed in a well ventilated environment.
W09 shows.	Fans abnormal stopped during operation. Please contact service center to replace them.
W10 shows.	BMS communication disconnected. Please contact service center to repair it.
Output powered but no buzzer and LED flashing. Only record on log	
W04 shows.	Charge the battery.
W05 shows.	Reduce the load.
W06 shows.	Utility voltage lower to a certain level, the output rating will be limited.
W11 shows.	Internal communication disconnected. Please contact service center to repair it.
W16, W17, W18 or W19 shows.	Check Battery status
WiFi mark is not displayed.	
Unit can't connect to the APP.	Check the Wi-Fi function enabled and icon available on the LCD then follow the Wi-Fi installation procedure to pair the Wi-Fi module with router and APP.
No function on USB charger ports.	
No power from the USB charger ports.	Check whether the USB charger function is enabled.

Appendix I: Parallel function

1. Introduction

This inverter can be used in parallel with two different operation modes.

1. Parallel operation in single phase is with up to 6 units. The supported maximum output power is 66KW/66KVA.
2. Maximum six units work together to support three-phase equipment. Maximum four units support one phase.

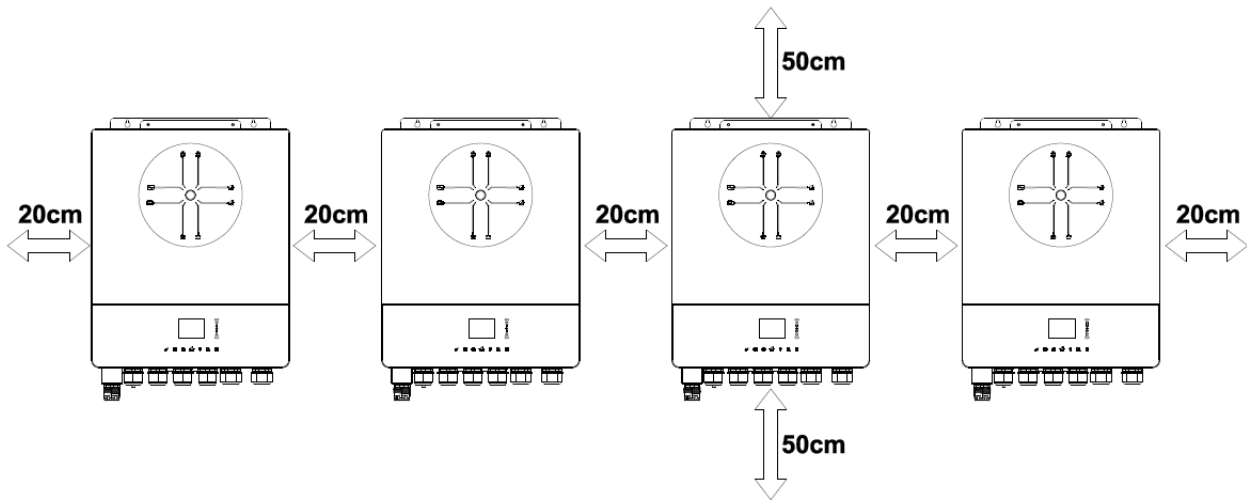

2. Mounting the Unit

When installing multiple units, please follow below chart.

NOTE: For proper air circulation to dissipate heat, allow a clearance of approx. 20 cm to the side and approx. 50 cm above and below the unit. Be sure to install each unit in the same level.

3. Wiring Connection

WARNING: It's REQUIRED to connect battery for parallel operation.

The cable size of each inverter is shown as below:

Recommended battery cable and terminal size for each inverter:

Wire Size	Cable mm ²	Ring Terminal Dimensions		Torque value
		D (mm)	L (mm)	
		1*4/0AWG	85	

WARNING: Be sure the length of all battery cables is the same. Otherwise, there will be voltage difference between inverter and battery to cause parallel inverters not working.

Ring terminal:

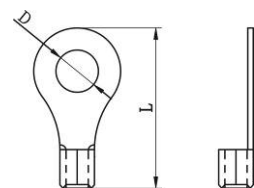

Recommended AC input and output cable size for each inverter:

AWG no.	Torque
6 AWG	1.4~ 1.6 Nm

You need to connect the cables of each inverter together. Take the battery cables for example: You need to use a connector or bus-bar as a joint to connect the battery cables together, and then connect to the battery terminal. The cable size used from joint to battery should be X times cable size in the tables above. "X" indicates the number of inverters connected in parallel.

Regarding AC input and output, please also follow the same principle.

CAUTION!! Please install the breaker at the battery and AC input side. This will ensure the inverter can be securely disconnected during maintenance and fully protected from over current of battery or AC input.

Recommended breaker specification of battery for each inverter:

1 unit*
250A/70VDC

*If you want to use only one breaker at the battery side for the whole system, the rating of the breaker should be X times current of 1 unit. "X" indicates the number of inverters connected in parallel.

Recommended breaker specification of AC input with single phase:

2 units	3 units	4 units	5 units	6 units
120A/230VAC	180A/230VAC	240A/230VAC	300A/230VAC	360A/230VAC

Note 1: Also, you can use 60A breaker with only 1 unit and install one breaker at its AC input in each inverter.

Note 2: Regarding three-phase system, you can use 4-pole breaker directly and the rating of the breaker should be compatible with the phase current limitation from the phase with maximum units

Recommended battery capacity

Inverter parallel numbers	2	3	4	5	6
Battery Capacity	200AH	400AH	400AH	600AH	600AH

WARNING! Be sure that all inverters will share the same battery bank. Otherwise, the inverters will transfer to fault mode.

4-1. Parallel Operation in Single phase

Two inverters in parallel:

Power Connection

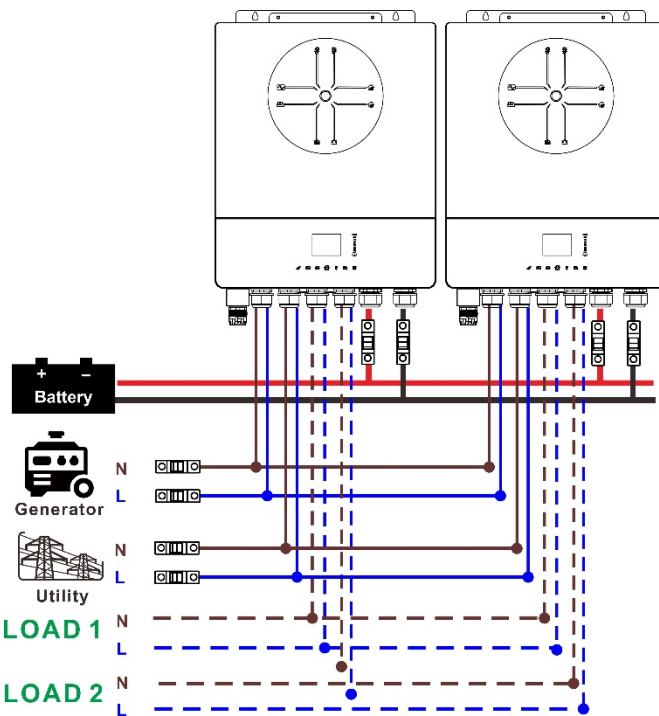

Communication Connection

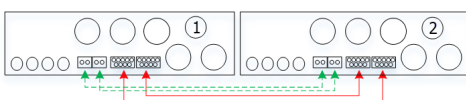

Three inverters in parallel:

Power Connection

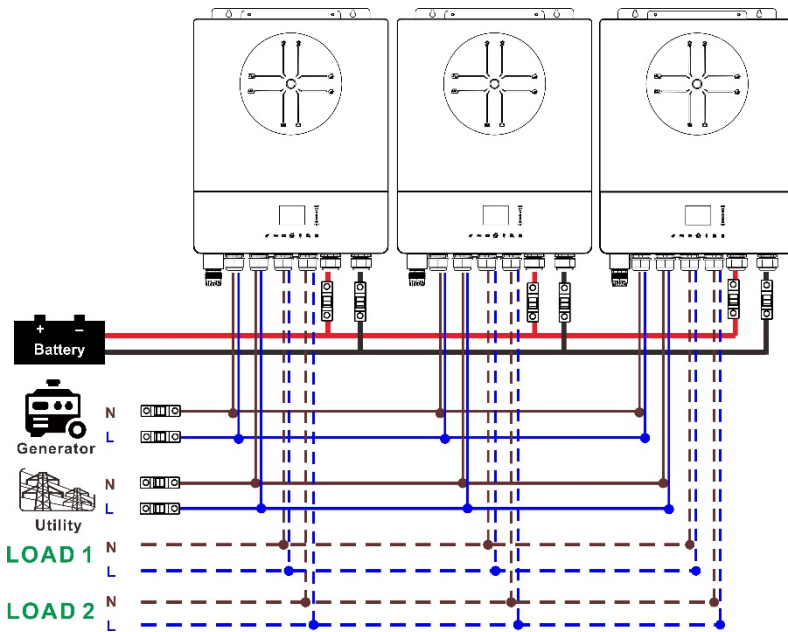

Communication Connection

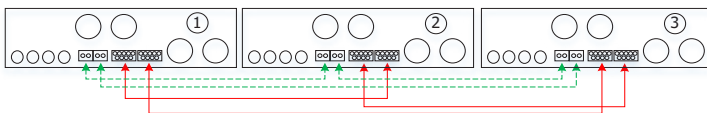

Four inverters in parallel:

Power Connection

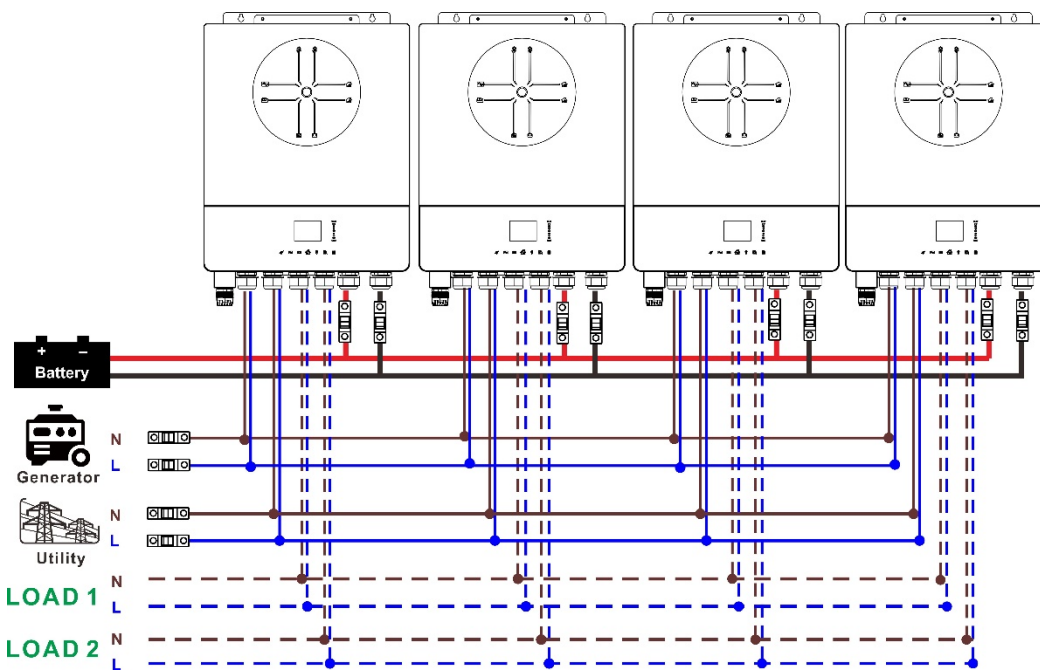

Communication Connection

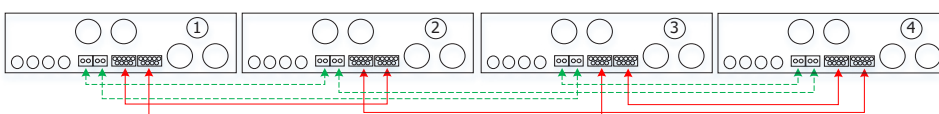

Five inverters in parallel:

Power Connection

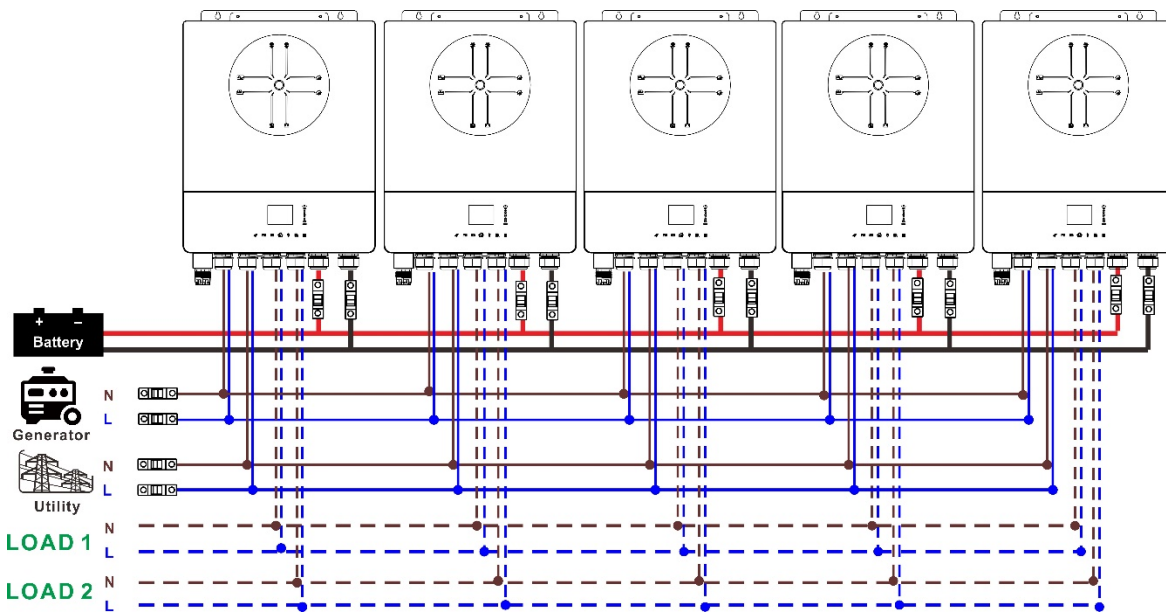

Communication Connection

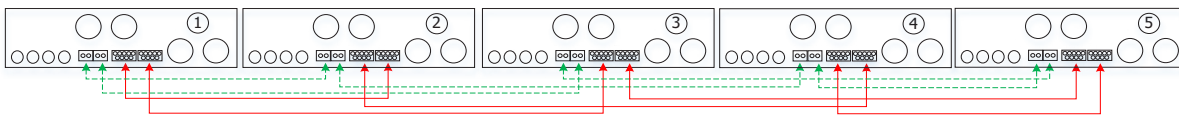

Six inverters in parallel:

Power Connection

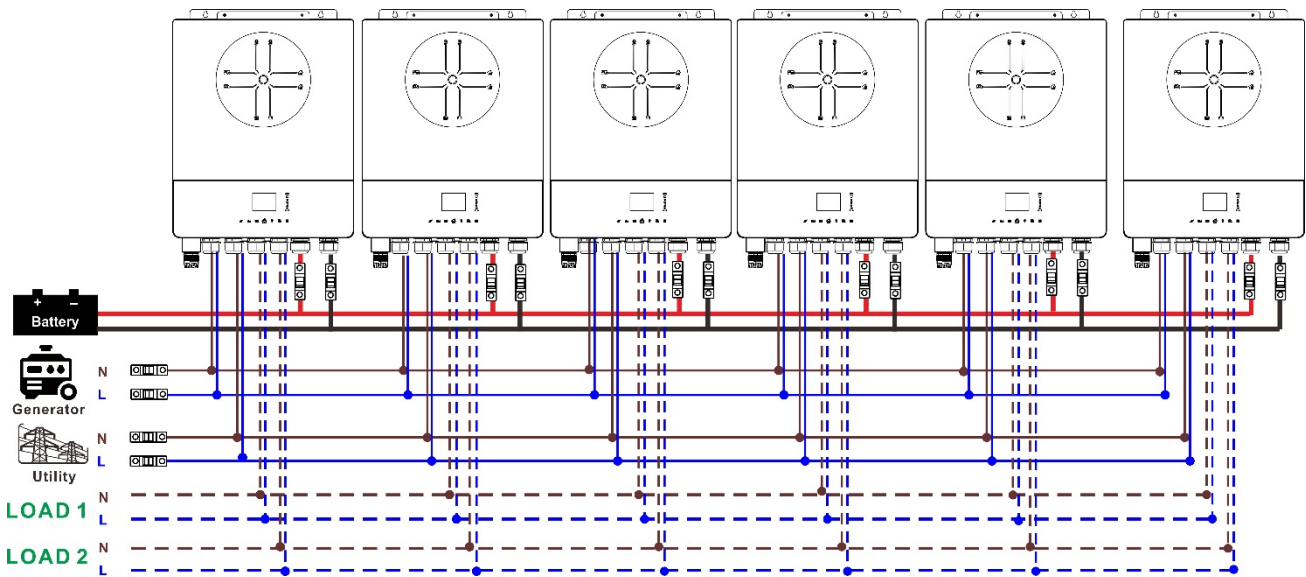

Communication Connection

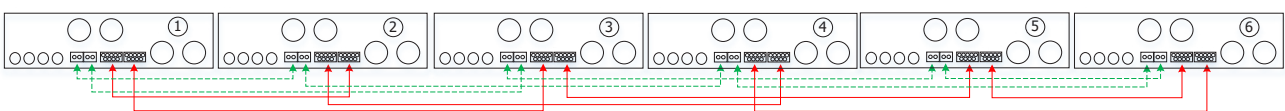

4-2. Support 3-phase equipment

Two inverters in each phase:

Power Connection

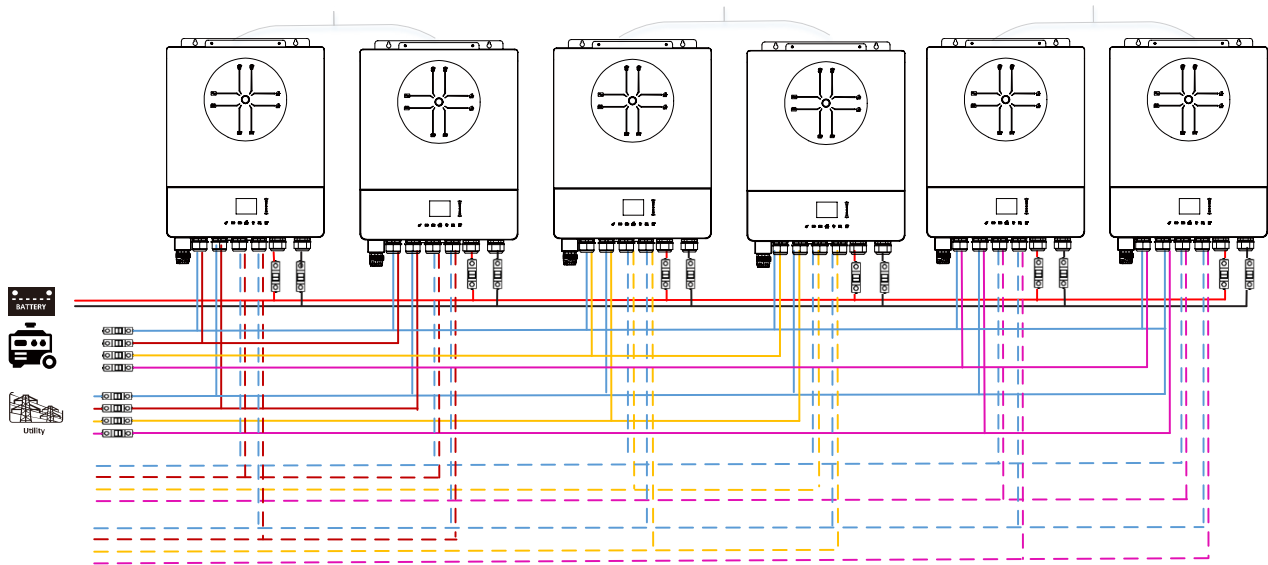

Communication Connection

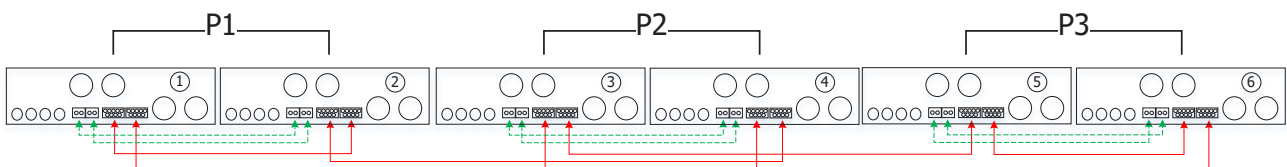

Four inverters in one phase and one inverter for the other two phases:

Power Connection

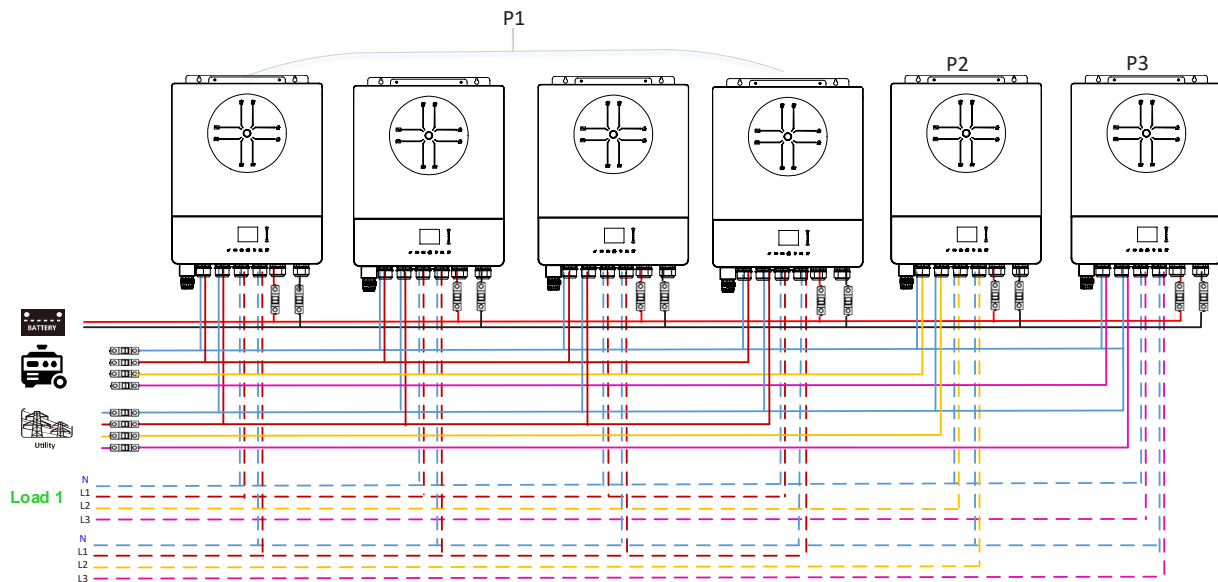

Communication Connection

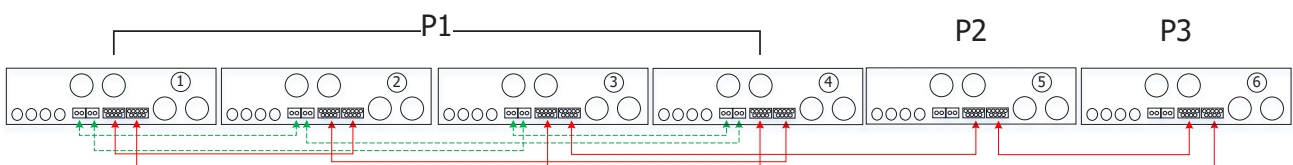

Three inverters in one phase, two inverters in second phase and one inverter for the third phase:

Power Connection

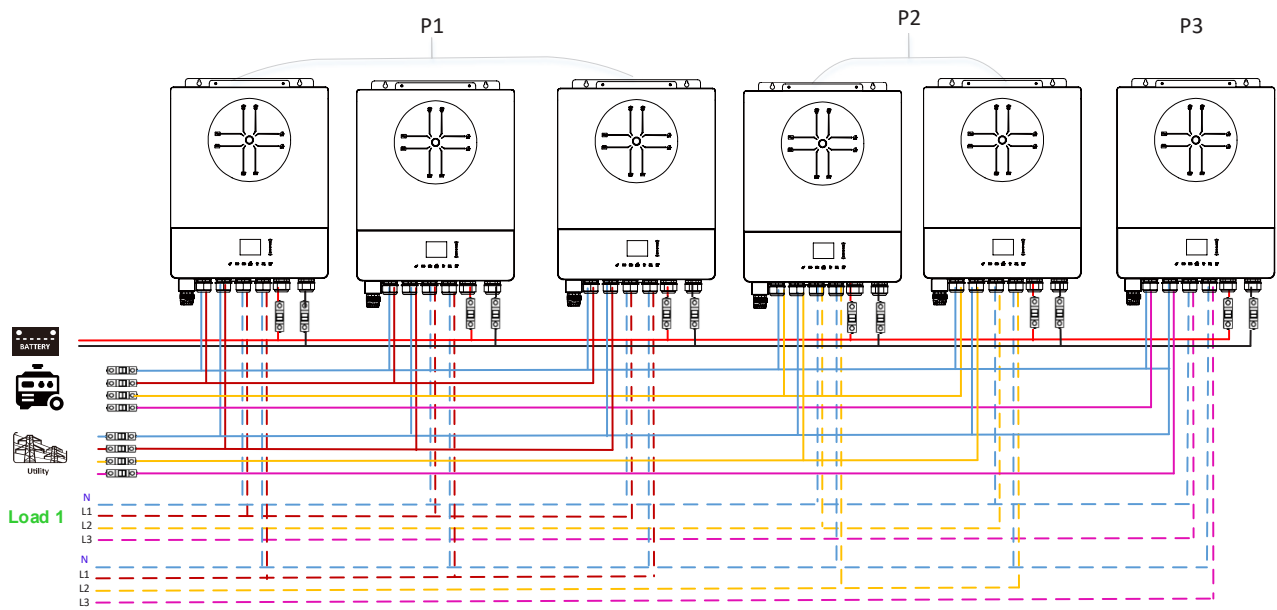

Communication Connection

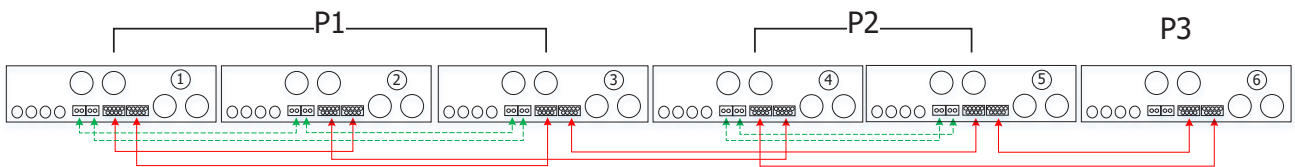

Three inverters in one phase and only one inverter for the remaining two phases:

Power Connection

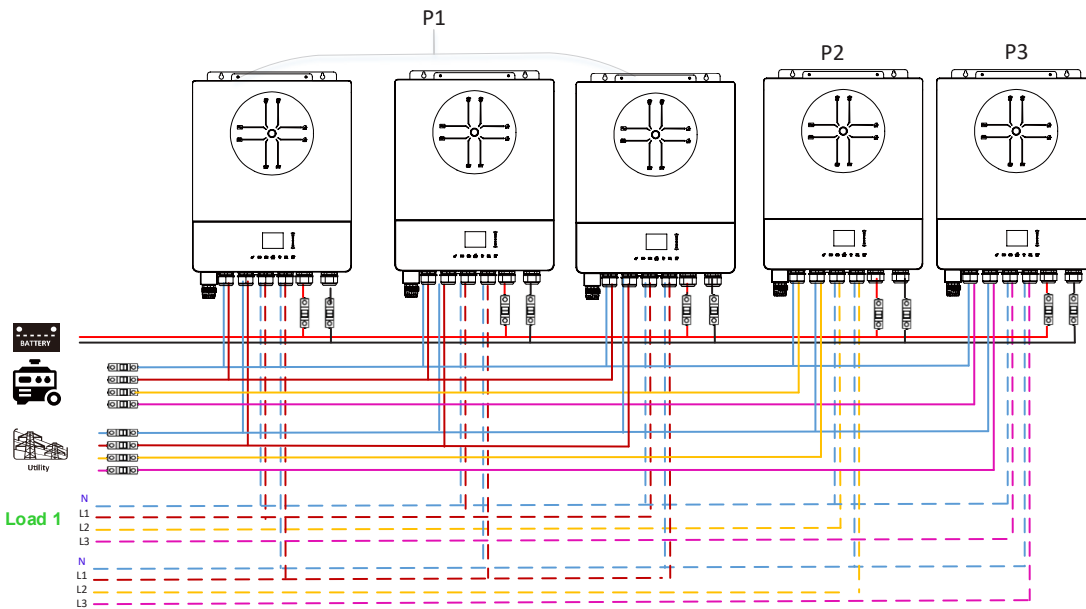

Communication Connection

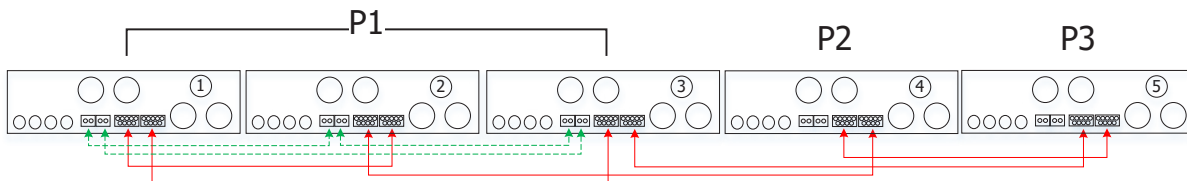

Two inverters in two phases and only one inverter for the remaining phase:

Power Connection

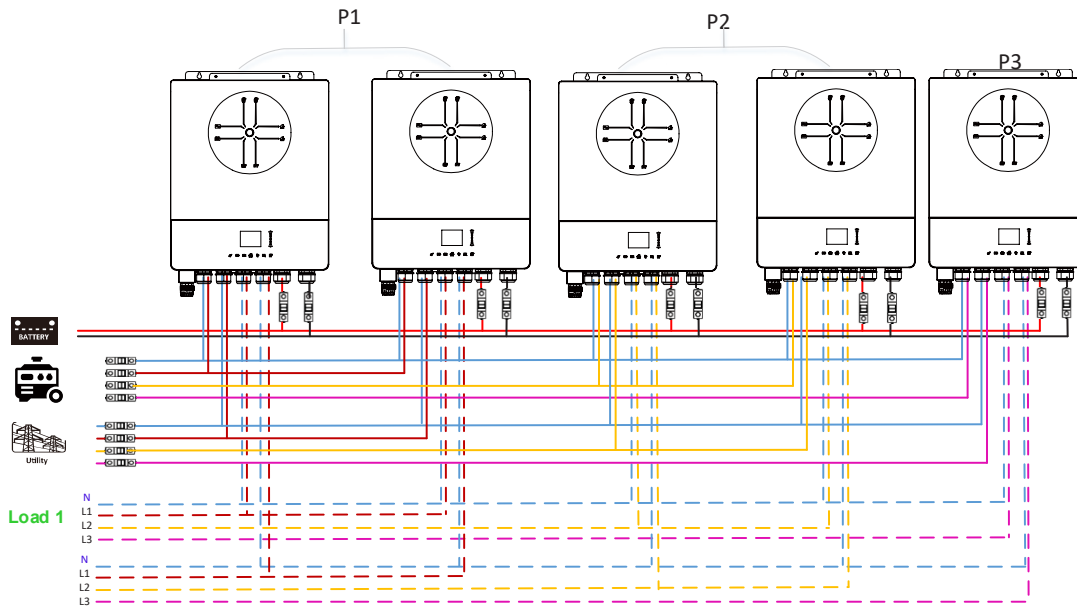

Communication Connection

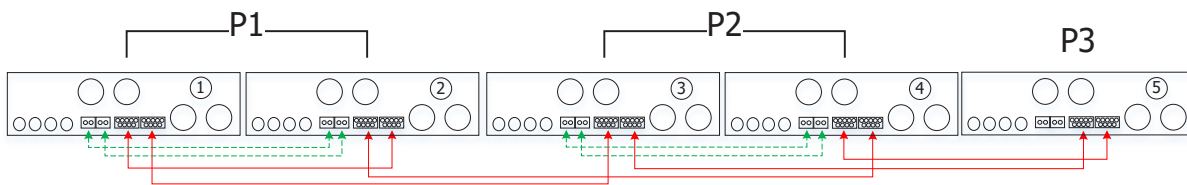

Two inverters in one phase and only one inverter for the remaining phases:

Power Connection

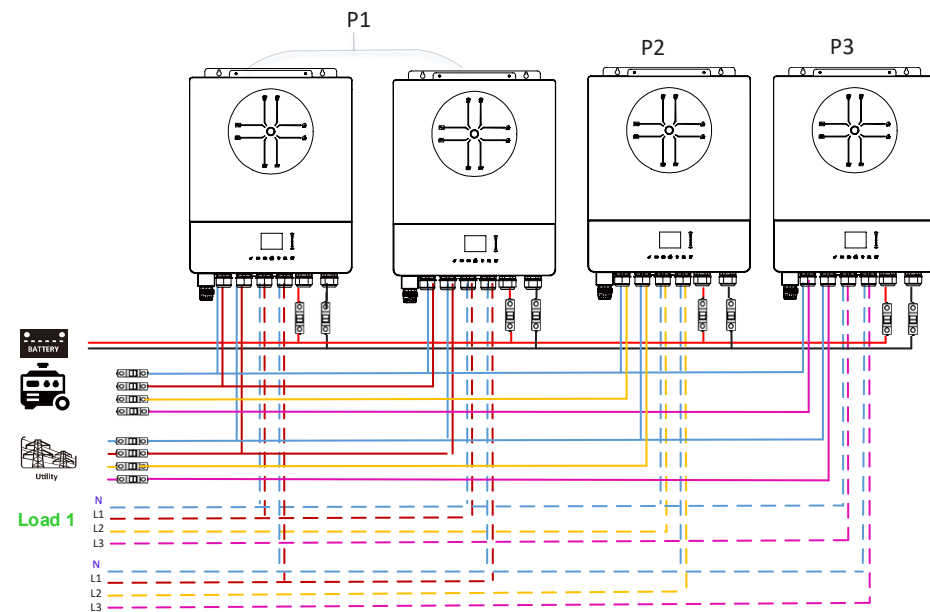

Communication Connection

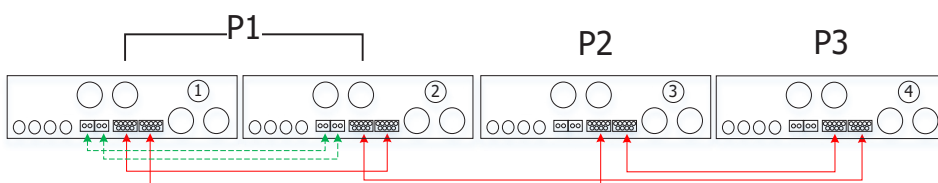

One inverter in each phase:

Power Connection

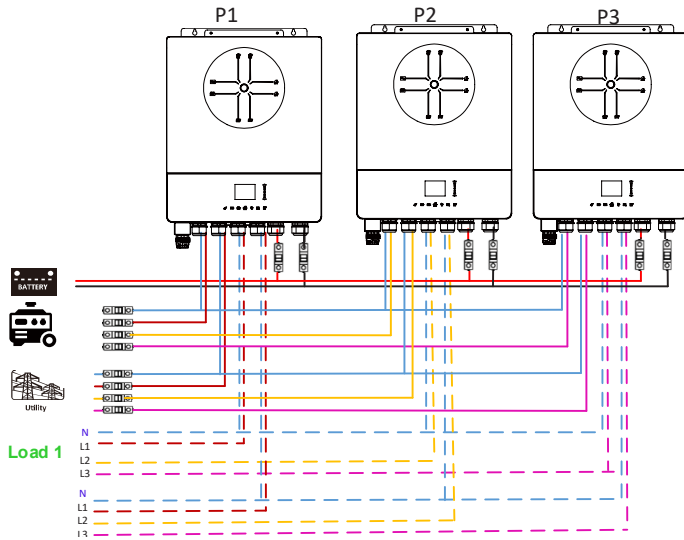

Communication Connection

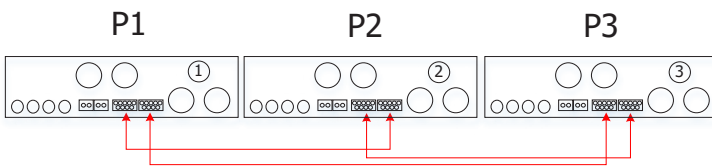

WARNING: Do not connect the current sharing cable between the inverters which are in different phases. Otherwise, it may damage the inverters.

5. PV Connection

Please refer to user manual of single unit for PV Connection.

CAUTION: Each inverter should connect to PV modules separately.

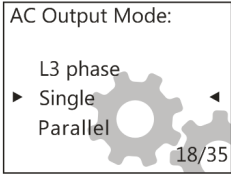
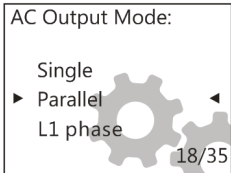
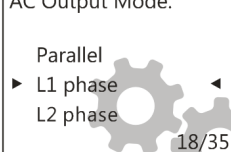

6. LCD Setting and Display

Setting Program:

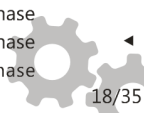
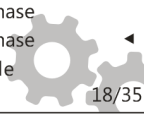
Description	Selectable option	
AC output mode *This setting is able to set up only when the inverter is in standby mode. Be sure that on/off switch is in "OFF" status.	Single AC Output Mode: L3 phase ▶ Single ◀ Parallel 	When the unit is operated alone, please select "Single"
	Parallel AC Output Mode: Single ▶ Parallel ◀ L1 phase 	When the units are used in parallel for single phase application, please select "Parallel". Please refer to 4-1 for detailed information.
	L1 phase: AC Output Mode: Parallel ▶ L1 phase ◀ L2 phase 	When the units are operated in 3-phase application, please choose phase to define each inverter. It is required to have at least 3 inverters or maximum 6 inverters to support three-phase equipment. It's required to have at

	L2 phase: AC Output Mode: L1 phase ▶ L2 phase L3 phase 	least one inverter in each phase or it's up to four inverters in one phase. Please refers to 4-2 for detailed information. Please select "L1 phase" for the inverters connected to L1 phase, "L2 phase" for the inverters connected to L2 phase and "L3 phase" for the inverters connected to L3 phase. Be sure to connect share current cable to units which are on the same phase. Do NOT connect share current cable between units on different phases.
	L3 phase: AC Output Mode: L2 phase ▶ L3 phase Single 	

Code Reference:

Code	Description	Icon on
NE	Unidentified unit master or slave	No master and slave icon show on LCD
HS	Master unit	
SL	Slave unit	

7. Commissioning

Parallel in single phase

Step 1: Check the following requirements before commissioning:

- Correct wire connection
- Ensure all breakers in Line wires of load side are open and each Neutral wires of each unit are connected together.

Step 2: Turn on each unit and set "Parallel" in LCD setting of each unit. And then shut down all units.

NOET: It's necessary to turn off switch when setting LCD program. Otherwise, the setting cannot be programmed.

Step 3: Turn on each unit.

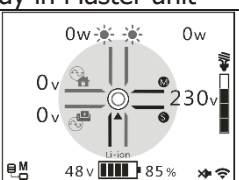
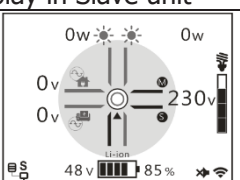
LCD display in Master unit	LCD display in Slave unit
	

NOTE: Master and slave units are randomly defined.

Step 4: Switch on all AC breakers of Line wires in AC input. It's better to have all inverters connect to utility at the same time. If not, it will display fault 26 in following-order inverters. However, these inverters will automatically restart. If detecting AC connection, they will work normally.

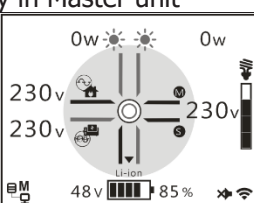
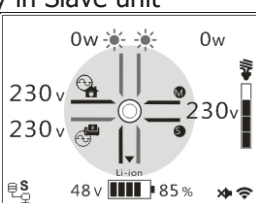
LCD display in Master unit	LCD display in Slave unit
	

Step 5: If there is no more fault alarm, the parallel system is completely installed.

Step 6: Please switch on all breakers of Line wires in load side. This system will start to provide power to the

load.

Support three-phase equipment

Step 1: Check the following requirements before commissioning:

- Correct wire connection
- Ensure all breakers in Line wires of load side are open and each Neutral wires of each unit are connected together.

Step 2: Turn on all units and configure AC output mode as L1, L2 and L3 sequentially. And then shut down all units.

NOET: It's necessary to turn off switch when setting LCD program. Otherwise, the setting cannot be programmed.

Step 3: Turn on all units sequentially.

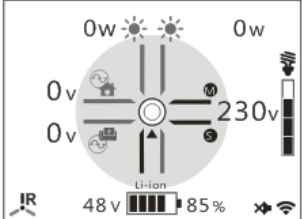
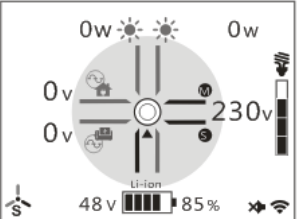
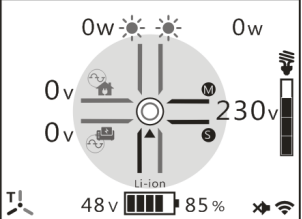
LCD display in L1-phase unit	LCD display in L2-phase unit	LCD display in L3-phase unit
		

Step 4: Switch on all AC breakers of Line wires in AC input. If AC connection is detected and three phases are matched with unit setting, they will work normally. Otherwise, the AC icon  will off and they will not work in line mode.

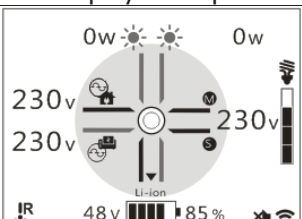
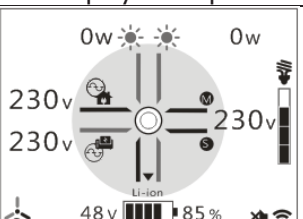
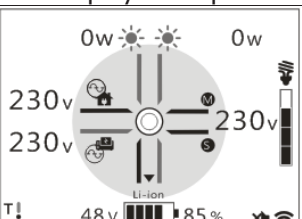
LCD display in L1-phase unit	LCD display in L2-phase unit	LCD display in L3-phase unit
		

Step 5: If there is no more fault alarm, the system to support 3-phase equipment is completely installed.

Step 6: Please switch on all breakers of Line wires in load side. This system will start to provide power to the load.

Note 1: To avoid overload occurring, before turning on breakers in load side, it's better to have whole system in operation first.

Note 2: Transfer time for this operation exists. Power interruption may happen to critical devices, which cannot bear transfer time.

Appendix II: BMS Communication Installation

1. Introduction

If connecting to lithium battery, it is recommended to purchase a custom-made RJ45 communication cable. Please check with your dealer or integrator for details.

This custom-made RJ45 communication cable delivers information and signal between lithium battery and the inverter. These information are listed below:

- Re-configure charging voltage, charging current and battery discharge cut-off voltage according to the lithium battery parameters.
- Have the inverter start or stop charging according to the status of lithium battery.

2. Pin Assignment for BMS Communication Port

	Definition
PIN 1	NC
PIN 2	NC
PIN 3	RS485B
PIN 4	NC
PIN 5	RS485A
PIN 6	CANH
PIN 7	CANL
PIN 8	GND

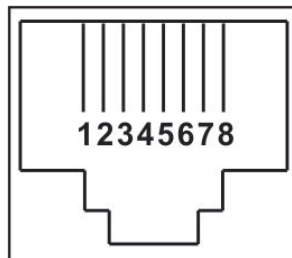

3. Lithium Battery Communication Configuration

LIO-4810-150A

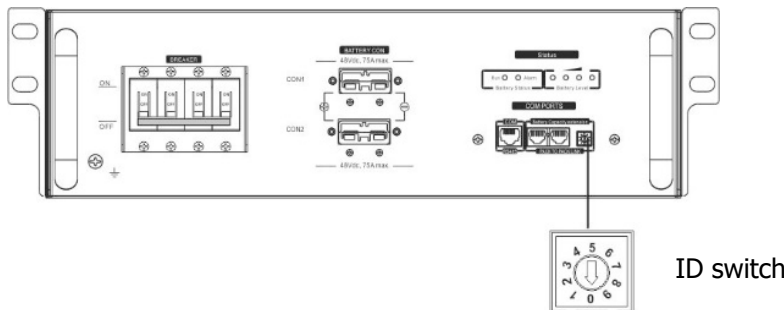

ESS LIO-I 4810

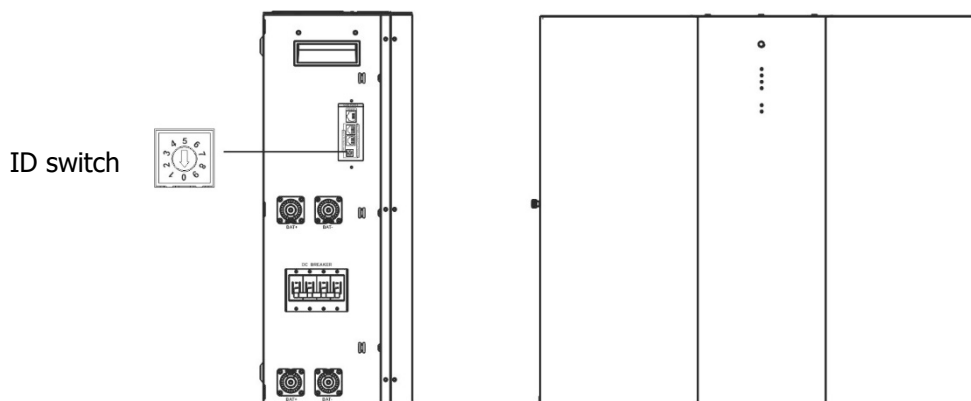

ID Switch indicates the unique ID code for each battery module. It's required to assign a unique ID to each battery module for normal operation. We can set up the ID code for each battery module by rotating the PIN number on the ID switch. From number 0 to 9, the number can be random; no particular order. Maximum 10 battery modules can be operated in parallel.

4. Installation and Operation

LIO-4810-150A/ESS LIO-I 4810

After ID no. is assigned for each battery module, please set up LCD panel in inverter and install the wiring connection as following steps.

Step 1: Use supplied RJ11 signal cable to connect into the extension port (P1 or P2).

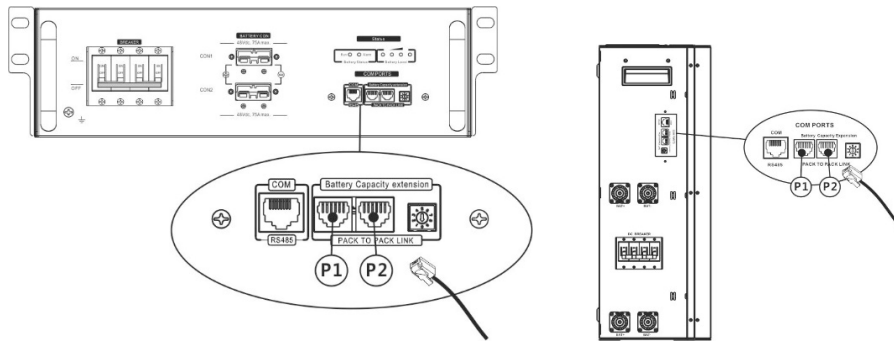

Step 2: Use supplied RJ45 cable (from battery module package) to connect inverter and Lithium battery.

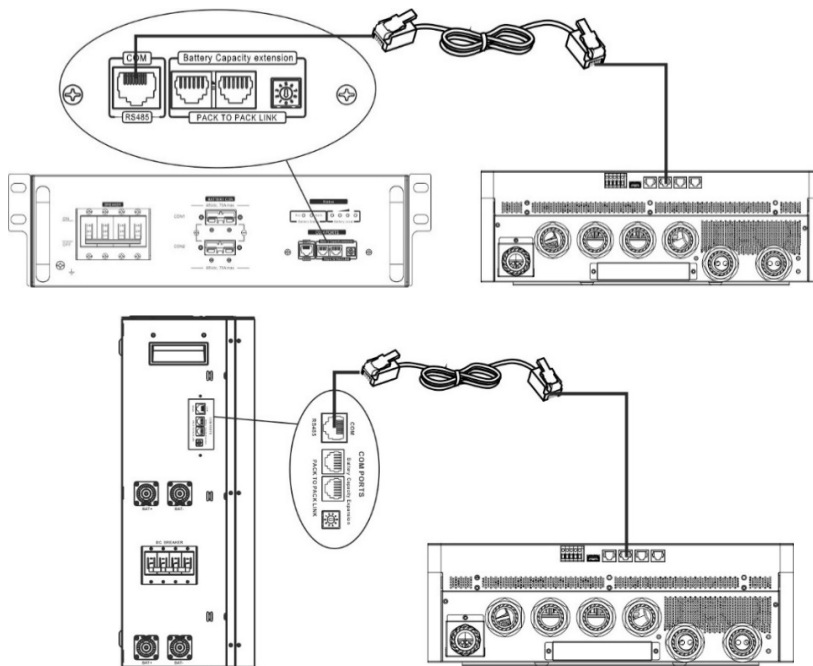

*** For multiple battery connection, please check battery manual for the details.**

Note for parallel system:

1. Only support common battery installation.
2. Use custom-made RJ45 cable to connect any inverter (no need to connect to a specific inverter) and Lithium battery. Simply set this inverter battery type to "LIB" in LCD battery type setting. Others should be "USE".

Step 3: Turn the breaker switch "ON". Now, the battery module is ready for DC output.

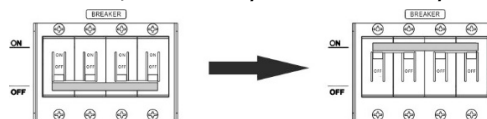

Step 4: Press Power on/off button on battery module for 5 secs, the battery module will start up.

*If the manual button cannot be approached, just simply turn on the inverter module. The battery module will be automatically turned on.

Step 5: Turn on the inverter.

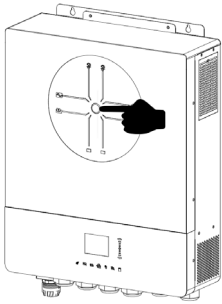

Step 6. Be sure to select battery type as "LIB" in LCD battery type setting.

If communication between the inverter and battery is successful, the Lithium icon **Li-ion** will show on LCD display. Generally speaking, it will take longer than 1 minute to establish communication.

Active Function

This function is to activate lithium battery automatically while commissioning. After battery wiring and commissioning is successfully, if battery is not detected, the inverter will automatically activate battery if the inverter is powered on.

4. LCD Display Information

Press "▲" or "▼" button to switch LCD display information. It will show battery pack and battery group number before "Main CPU version checking" as shown below.

Selectable information	LCD display
Battery pack numbers & Battery group numbers	<p>Battery pack numbers = 3, battery group numbers = 1</p>

5. Code Reference

Related information code will be displayed on LCD screen. Please check inverter LCD screen for the operation.

Warning Code	Description
W10	<p>Communication lost (only available when the battery type is not setting as "AGM", "Flooded" or "User-Defined".)</p> <ul style="list-style-type: none"> After battery is connected, communication signal is not detected for 3 minutes, buzzer will beep. After 10 minutes, inverter will stop charging and discharging to lithium battery. <p>Communication lost occurs after the inverter and battery is connected successfully, buzzer beeps immediately.</p>
W16	If battery status is not allowed to charge and discharge after the communication between the inverter and battery is successful.
W17	If battery status is not allowed to charge after the communication between the inverter and battery is successful.
W18	If battery status must to be charged after the communication between the inverter and battery is successful.
W19	If battery status is not allowed to discharge after the communication between the inverter and battery is successful.

Appendix III: The Wi-Fi Operation Guide

1. Introduction

Wi-Fi module can enable wireless communication between inverter and monitoring platform. Users can remote monitoring and controlling inverter easily by using the i.Solar APP.

The major functions of this i.Solar APP:

- Delivers device status during normal operation.
- Allows to configure device setting after installation.
- Notifies users when a warning or alarm occurs.
- Allows users to query inverter history data.

2. i.Solar App

2-1. Download and install APP

Please find "i.Solar" app from Apple® store or Google® Play Store. Install this app in your mobile phone.



(iOS)



(Android)

2-2. Initial Setup

- Turn on the unit.
- Open the Wi-Fi settings from your smart phone.
- Connect your smart phone to the Wi-Fi module. The Wi-Fi named starts with "FC41D_".
- Default password for the Wi-Fi module is: 12345678

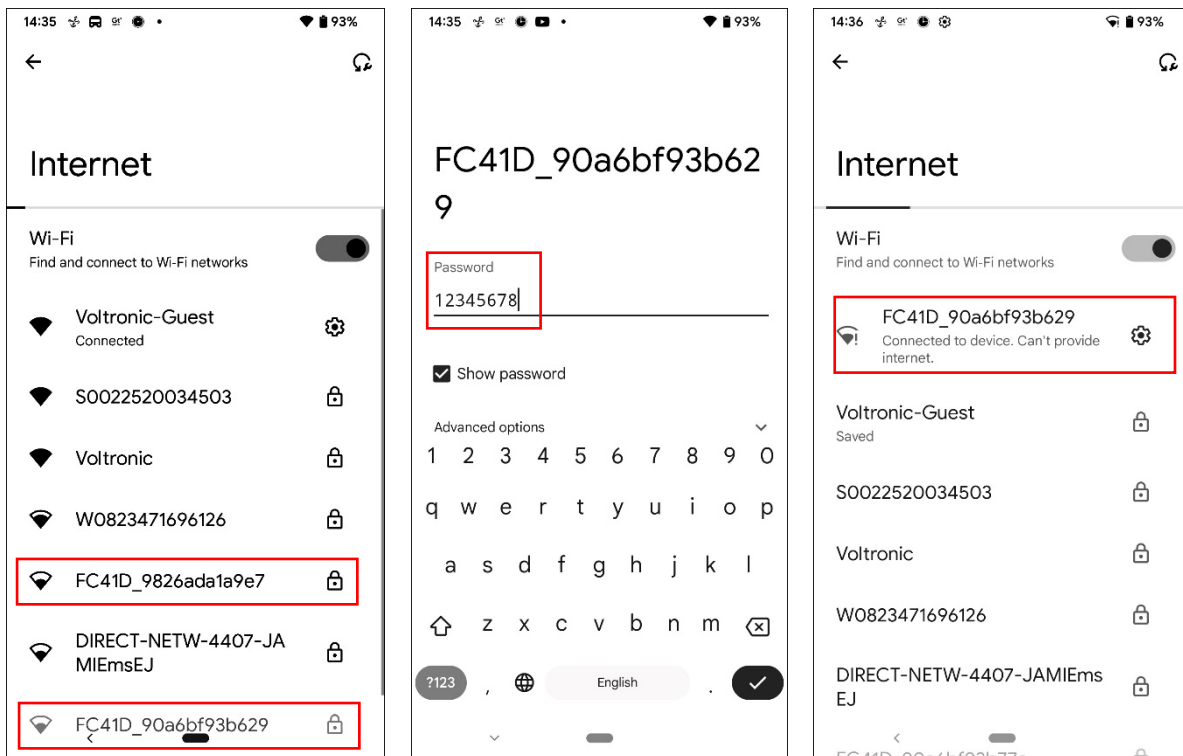

- Once the Wi-Fi connection is successful, click the i.Solar App installed on the phone to enter the login page. Then, click the "Network Config" button to enter the Wi-Fi configuration page.

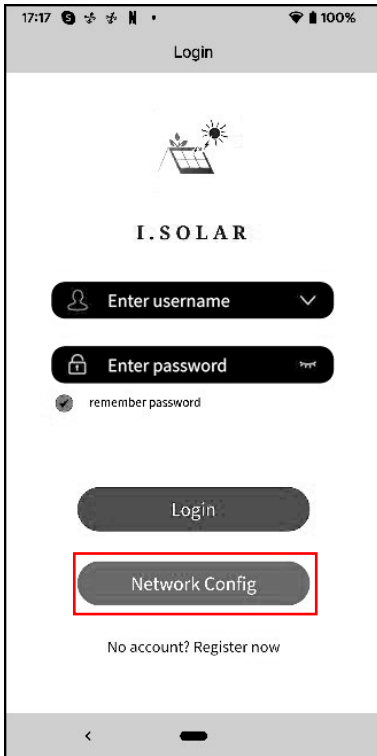

- The configuration page of the "Network Config" shown as following.

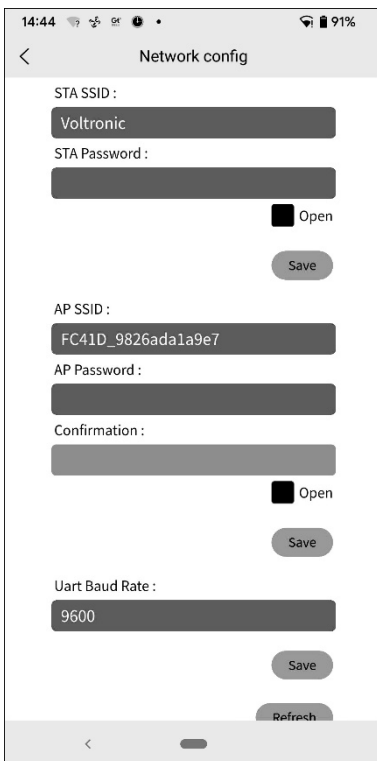

- Enter your router name (STA SSID) and router password (STA Password), then click the "Save" button to complete the setting.

If you check "Open" checkbox, you only need to enter the router name (STA SSID), no need to enter the router password. Then, click the "Save" button to complete the setting.

The Wi-Fi module only could connect the router at **2.4GHz**.



- Enter the Wi-Fi name (AP SSID) and Wi-Fi password (AP Password) of the Wi-Fi module, confirm the password again and click the "Save" button to complete the setting of the Wi-Fi module.

If you check "Open" checkbox, you only need to enter the Wi-Fi name (AP SSID), no need to enter the Wi-Fi password and Confirmation. Then, click the "Save" button to complete the setting.

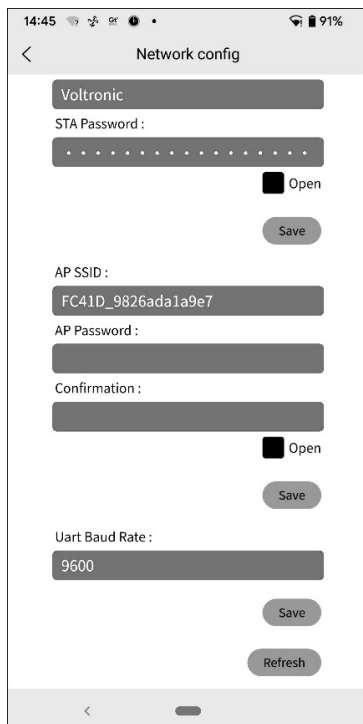

- After configuration, please **forget** the Wi-Fi module on the smartphone to avoid automatic connection and unable to access the Internet.

2-3. Login

- Connect your smart phone to the router.
- Registration at first time.

After fill in user name and password, click the "Register" button to complete the user registration. Once registration is complete, click "Click to log in" or return to the previous page (click the left arrow to return to the login page). Then, enter the registered user name and password to log in.

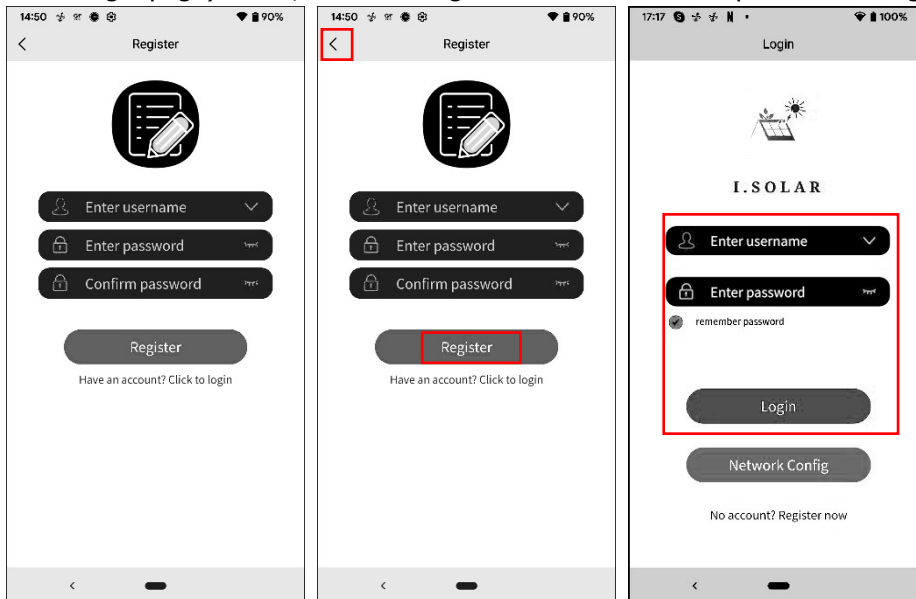

2-4. Home Page

- After login, the default Home page will appear.
 - Tap the icon (located on the right top) to enter the page to add, delete or rename the device.
- Input the device serial number to add the device.

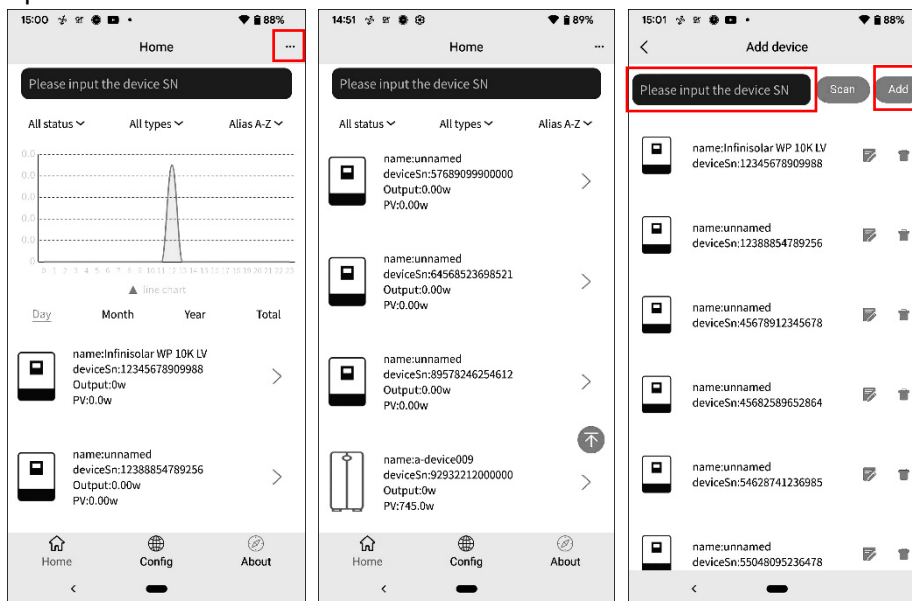

Rename or delete the device

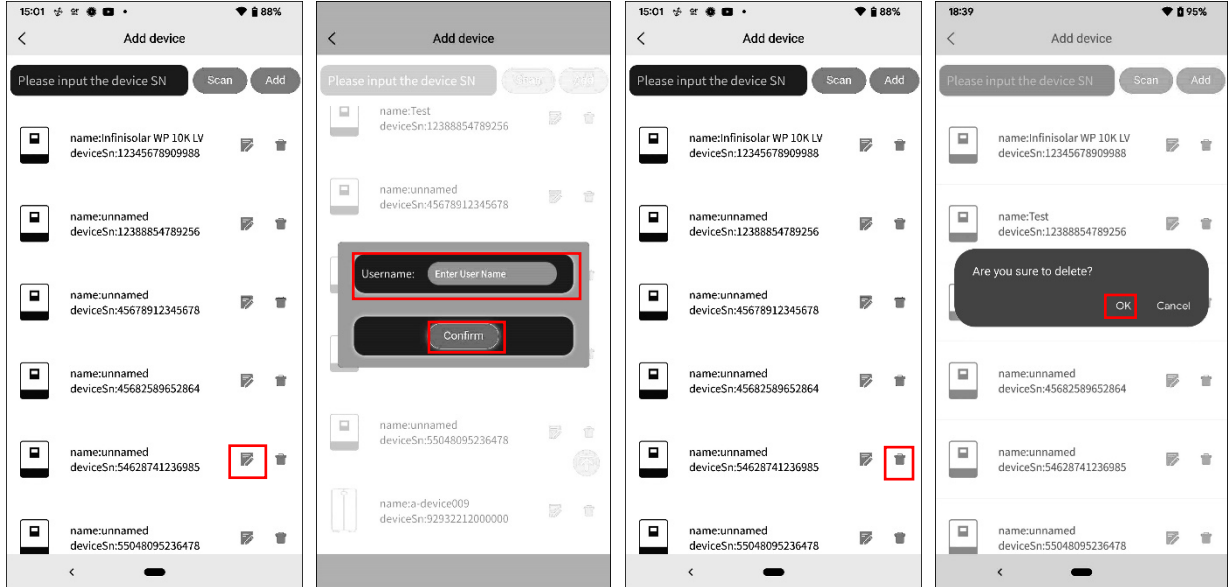

Above is the chart data area:

Day: Click the button to query the hourly power generation data of the current day.

Month: Click the button to query the daily power generation data of the current month.

Year: Click the button to query the monthly power generation data of the current year.

Total: Click the button to query the annual power generation data.

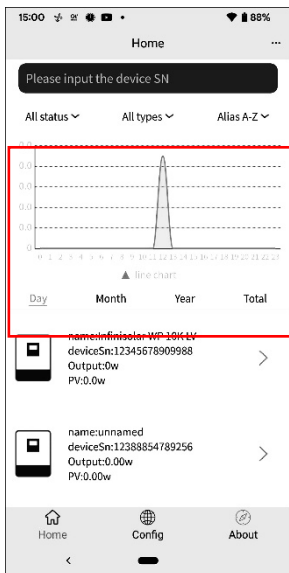

2-5. Real-time data

- Energy: displays battery power, grid power, solar power, and load consumption.

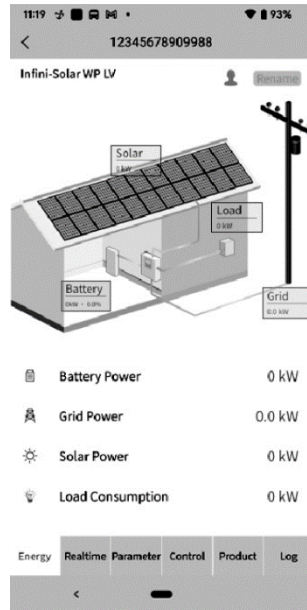

Rename the device.

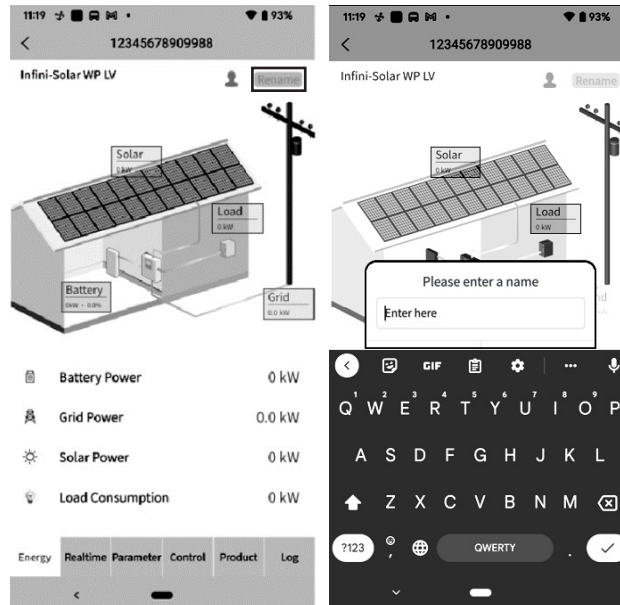

- Real-time: displays solar, grid, load, and battery information.

Above is the chart data area:

Day: Click the button to query the hourly power generation data of the current day.

Month: Click the button to query the daily power generation data of the current month.

Year: Click the button to query the monthly power generation data of the current year.

Total: Click the button to query the annual power generation data.

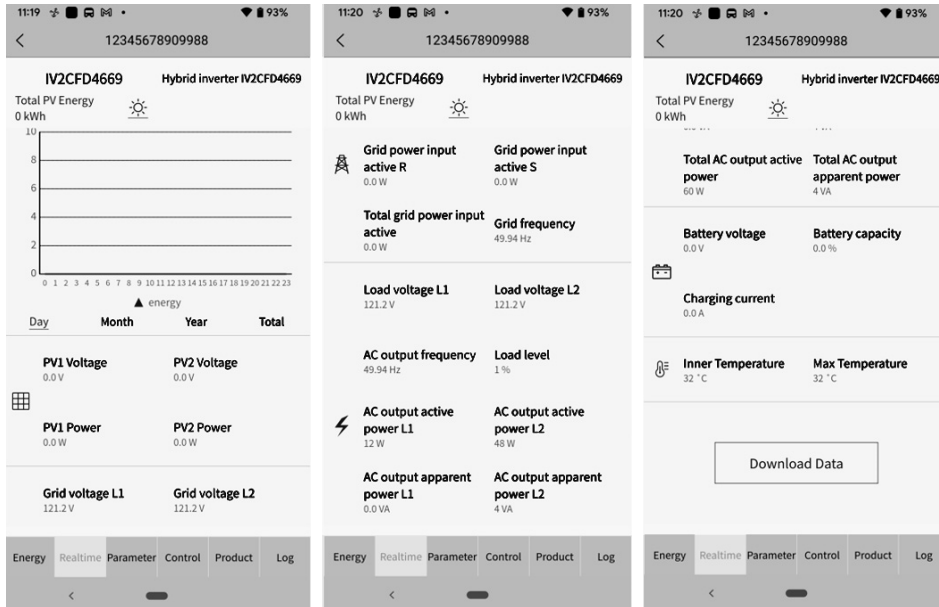

2-6. Parameter

Displays the setting items. Different models, the setting items on the parameter page will be different.

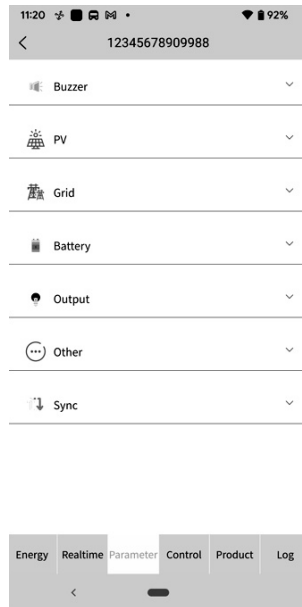

Tap the icon, select the setting and click the "Apply" button to change the setting.

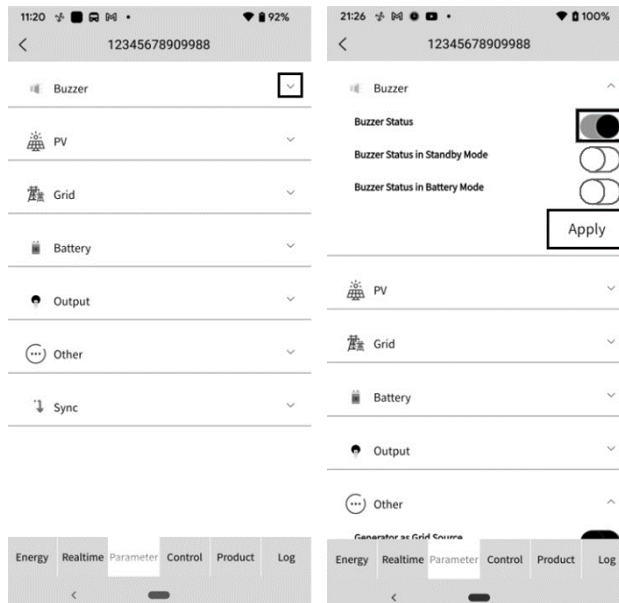

2-7. Control:

Remote control power on/off (The control item not support all models)

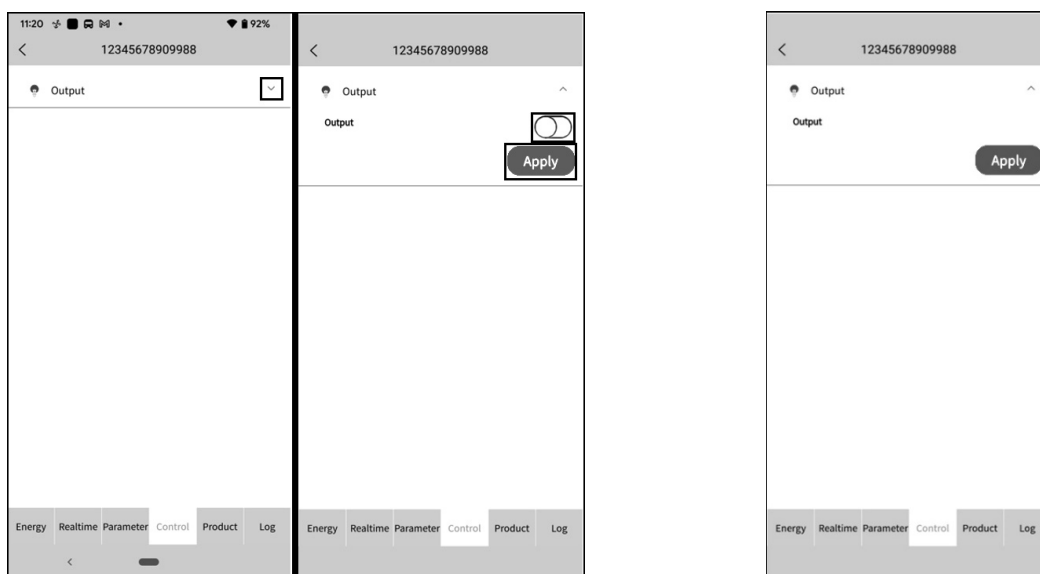

2-8. Product

Firmware upgrade, displays product information and rating information.

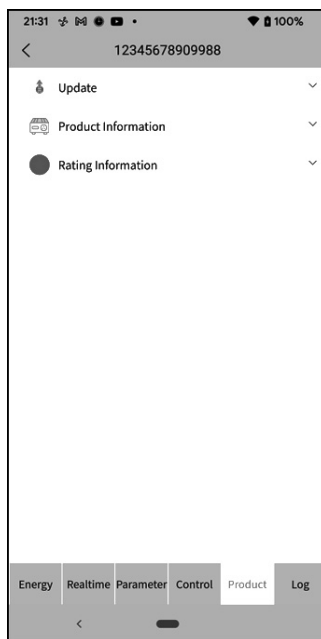

2-9. Log

Change password, remove account and change language

- Log: displays data log, solar power generation log, load consumption log and event.
Data log: Tap the time, select the date and click the "Browse" button to update log.

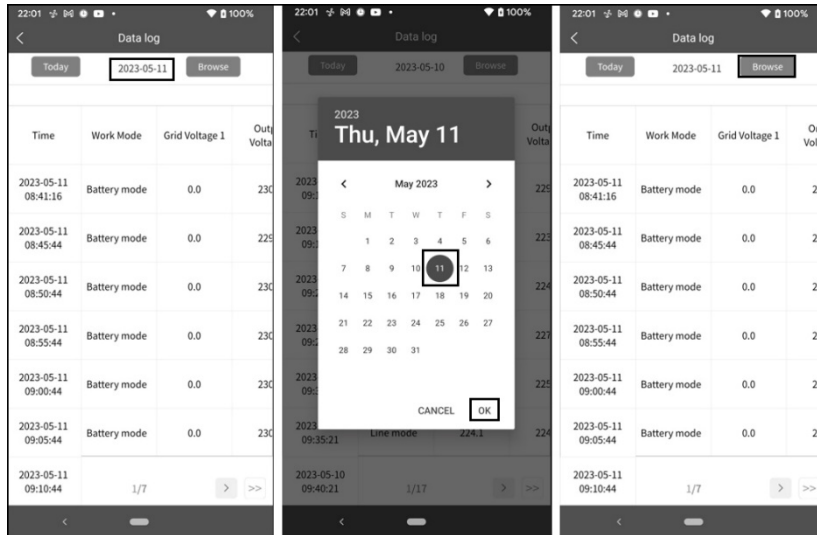

Power Generation Log: Tap the time, select the day, month or year, and click the "Done" button to update log.

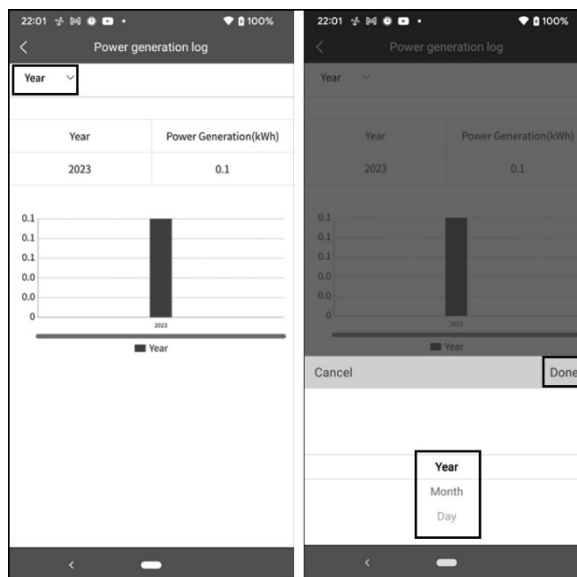

Event log: Tap the time, select the month and click the "Browse" button to update log.

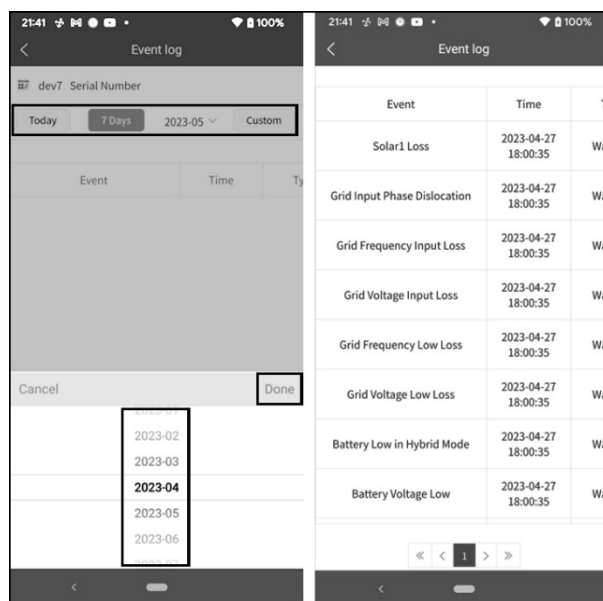

2-10. Configuration: change password, remove account and change language

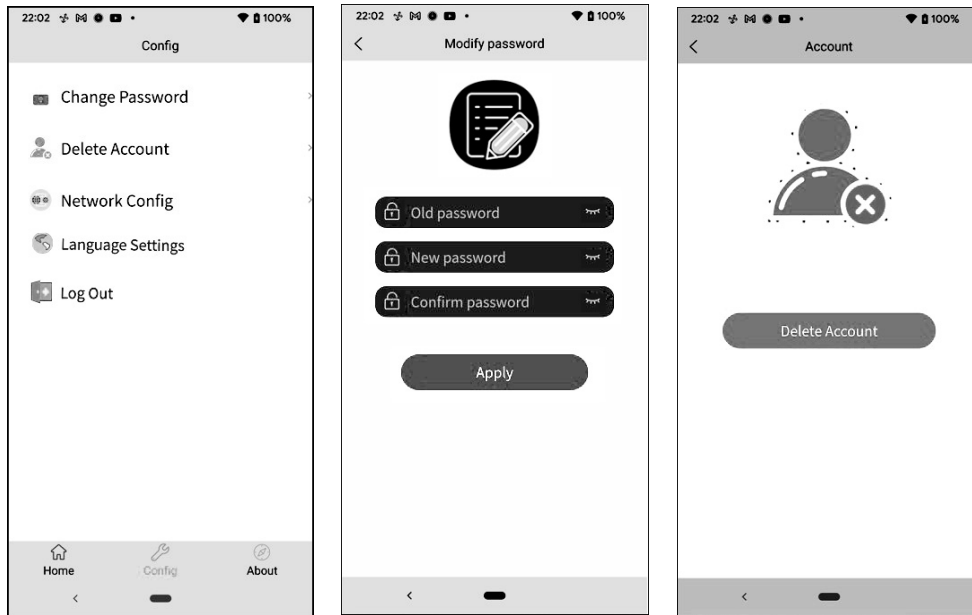

2-11. About

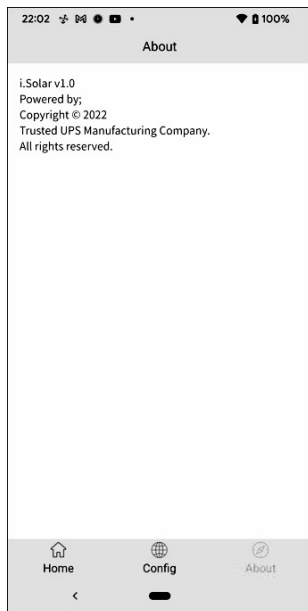

Appendix IV: The CT Operation Guide

With CT connected, hybrid inverter can be easily integrated into the existing household system. It's to arrange self-consumption via CT to control power generation and battery charging of the inverter.

1. Single commissioning

Step 1. Power off the inverter and connect the external CT by using the tool accessory to install on the spring terminal block. Be noted the mark of current flow direction on the CT should point to the Inverter and the polarity on connecting CT wires on the terminal block should be followed as "L+" vs red wire and "L-" vs white wire.

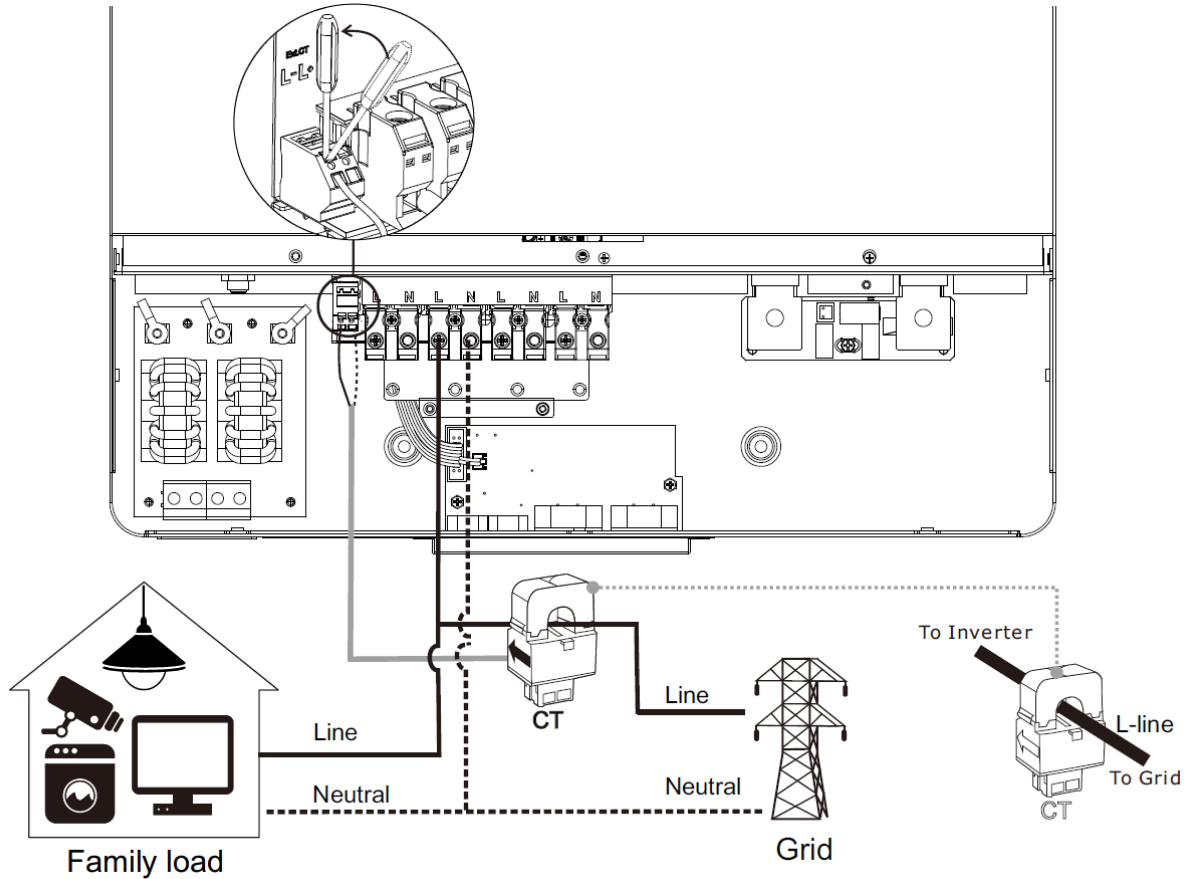

Step 2: Power on the inverter

Step 3: Enter LCD setting on the inverter with CT sensor connected and set CT function to "enable".

External CT function	Disable (default)	Enable
	<div style="border: 1px solid black; padding: 5px;"> External CT function: Enabled ▶ Disabled </div>	<div style="border: 1px solid black; padding: 5px;"> External CT function: ▶ Enabled Disabled </div>

2. Parallel commissioning

Step 1. Power off the inverter and connect the CT sensor according to the wiring diagram below. For other parallel circuits, please follow Appendix I.

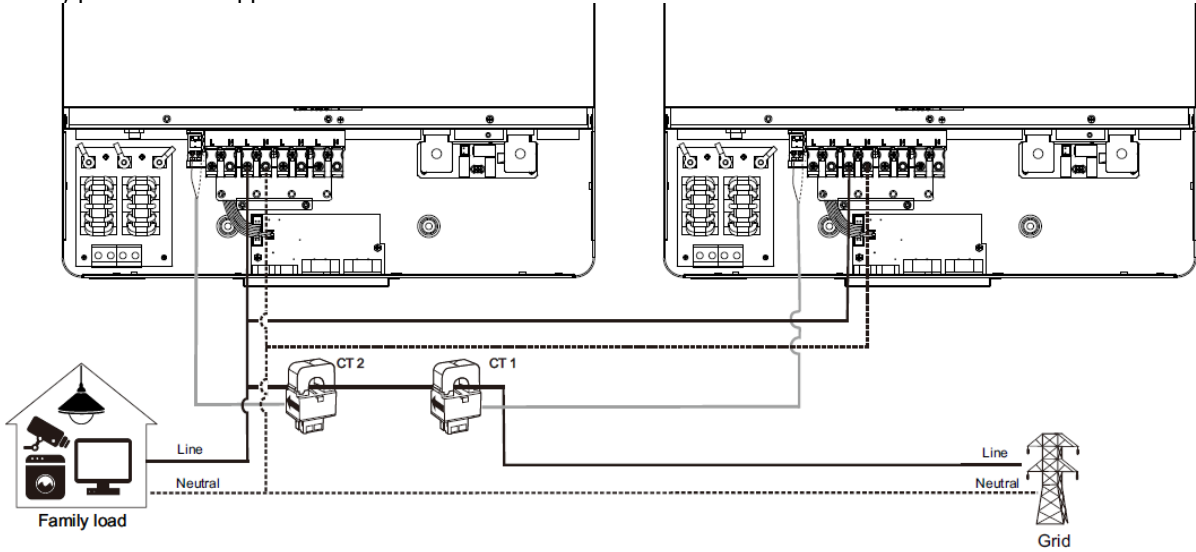

Step 2: Power on each inverter.

Step 3: Enter LCD setting on the inverter with CT sensor connected and set CT function to "enable". Same as single phase setting

3. Three-phase commissioning

Step 1. Power off the the inverter and connect the CT sensor according to the wiring diagram below. For other parallel circuits, please follow Appendix I.

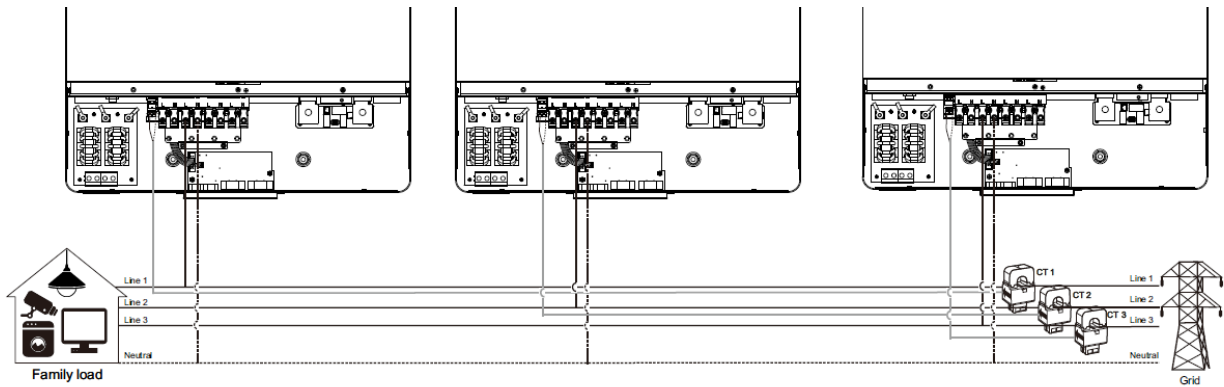

Step 2: Power on each inverter.

Step 3: Enter LCD setting on the inverter with CT sensor connected and set CT function to "enable". Same as single phase setting

IMPORTANT ATTENTION :

If applying CT function during parallel operation, it is required to have each inverter from parallel system connected to CT sensor. Be sure to enable LCD external CT function on all inverters with CT connected. Otherwise, it will cause CT function not working during parallel operation.