

MIS III 4K & 6K TWIN User Manual

Table Of Contents

ABOUT THIS MANUAL	1
Purpose	1
Scope	1
SAFETY INSTRUCTIONS.....	1
INTRODUCTION	2
Features	2
Basic System Architecture	2
Product Overview	3
INSTALLATION.....	4
Unpacking and Inspection	4
Preparation	4
Mounting the Unit.....	4
Battery Connection	5
AC Input/Output Connection	7
PV Connection.....	8
Final Assembly	10
Remote Display Panel Installation	11
Communication Options	12
BMS Communication.....	13
Dry Contact Signal.....	13
OPERATION.....	14
Power ON/OFF	14
Operation and Display Panel.....	14
LCD Display Icons.....	15
LCD Setting.....	18
Display Setting	31
Operating Mode Description	36
Battery Equalization Description	39
Fault Reference Code.....	40
Warning Indicator.....	41
SPECIFICATIONS	42
Table 1 Line Mode Specifications	42
Table 2 Inverter Mode Specifications.....	43
Table 3 Charge Mode Specifications.....	44
Table 4 General Specifications	44
TROUBLE SHOOTING	45
Appendix I: BMS Communication Installation.....	46
Appendix II: The Wi-Fi Operation Guide in Remote Panel	53

ABOUT THIS MANUAL

Purpose

This manual describes the assembly, installation, operation and troubleshooting of this unit. Please read this manual carefully before installations and operations. Keep this manual for future reference.

Scope

This manual provides safety and installation guidelines as well as information on tools and wiring.

SAFETY INSTRUCTIONS



WARNING: All safety instructions in this document must be read, understood and followed. Failure to follow these instructions will result in death or serious injury.

1. Before using the unit, read all instructions and cautionary markings on the unit, the batteries and all appropriate sections of this manual.
2. **CAUTION** --To reduce risk of injury, charge only deep-cycle lead acid type rechargeable batteries. Other types of batteries may burst, causing personal injury and damage.
3. Do not disassemble the unit. Take it to a qualified service center when service or repair is required. Incorrect re-assembly may result in a risk of electric shock or fire.
4. To reduce risk of electric shock, disconnect all wirings before attempting any maintenance or cleaning. Turning off the unit will not reduce this risk.
5. **CAUTION** – Only qualified personnel can install this device with battery.
6. **NEVER** charge a frozen battery.
7. For optimum operation of this inverter/charger, please follow required spec to select appropriate cable size. It's very important to correctly operate this inverter/charger.
8. Be very cautious when working with metal tools on or around batteries. A potential risk exists to drop a tool to spark or short circuit batteries or other electrical parts and could cause an explosion.
9. Please strictly follow installation procedure when you want to disconnect AC or DC terminals. Please refer to INSTALLATION section of this manual for the details.
10. One piece of 150A fuse is provided as over-current protection for the battery supply.
11. **GROUNDING INSTRUCTIONS** -This inverter/charger should be connected to a permanent grounded wiring system. Be sure to comply with local requirements and regulation to install this inverter.
12. **NEVER** cause AC output and DC input short circuited. Do NOT connect to the mains when DC input short circuits.
13. **Warning!!** Only qualified service persons are able to service this device. If errors still persist after following troubleshooting table, please send this inverter/charger back to local dealer or service center for maintenance.
14. **WARNING:** Because this inverter is non-isolated, only three types of PV modules are acceptable: single crystalline, poly crystalline with class A-rated and CIGS modules. To avoid any malfunction, do not connect any PV modules with possible current leakage to the inverter. For example, grounded PV modules will cause current leakage to the inverter. When using CIGS modules, please be sure NO grounding.
15. **CAUTION:** It's requested to use PV junction box with surge protection. Otherwise, it will cause damage on inverter when lightning occurs on PV modules.

INTRODUCTION

This is a multi-function inverter, combining functions of inverter, solar charger and battery charger to offer uninterruptible power support in a single package. The comprehensive LCD display offers user-configurable and easy-accessible button operations such as battery charging current, AC or solar charging priority, and acceptable input voltage based on different applications.

Features

- Pure sine wave inverter
- Configurable input voltage ranges for home appliances and personal computers via LCD control panel
- Configurable battery charging current based on applications via LCD control panel
- Configurable AC/Solar Charger priority via LCD control panel
- Compatible to utility mains or generator power
- Auto restart while AC is recovering
- Overload / Over temperature / short circuit protection
- Smart battery charger design for optimized battery performance
- Cold start function
- Removable LCD control module
- Multiple communication ports for BMS (RS485, CAN-BUS, RS232)
- Built-in WiFi for mobile monitoring (Requires App), OTG USB function, dusk filters
- Configurable AC/PV Output usage timer and prioritization

Basic System Architecture

The following illustration shows basic application for this unit. It also required the following devices to have a complete running system:

- Generator or Utility mains.
- PV modules

Consult with your system integrator for other possible system architectures depending on your requirements.

This inverter can power various appliances in home or office environment, including motor-type appliances such as tube light, fan, refrigerator and air conditioners.

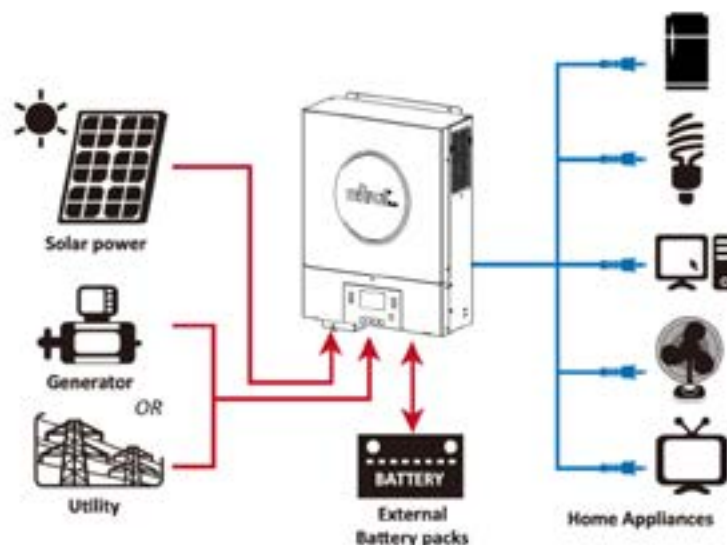
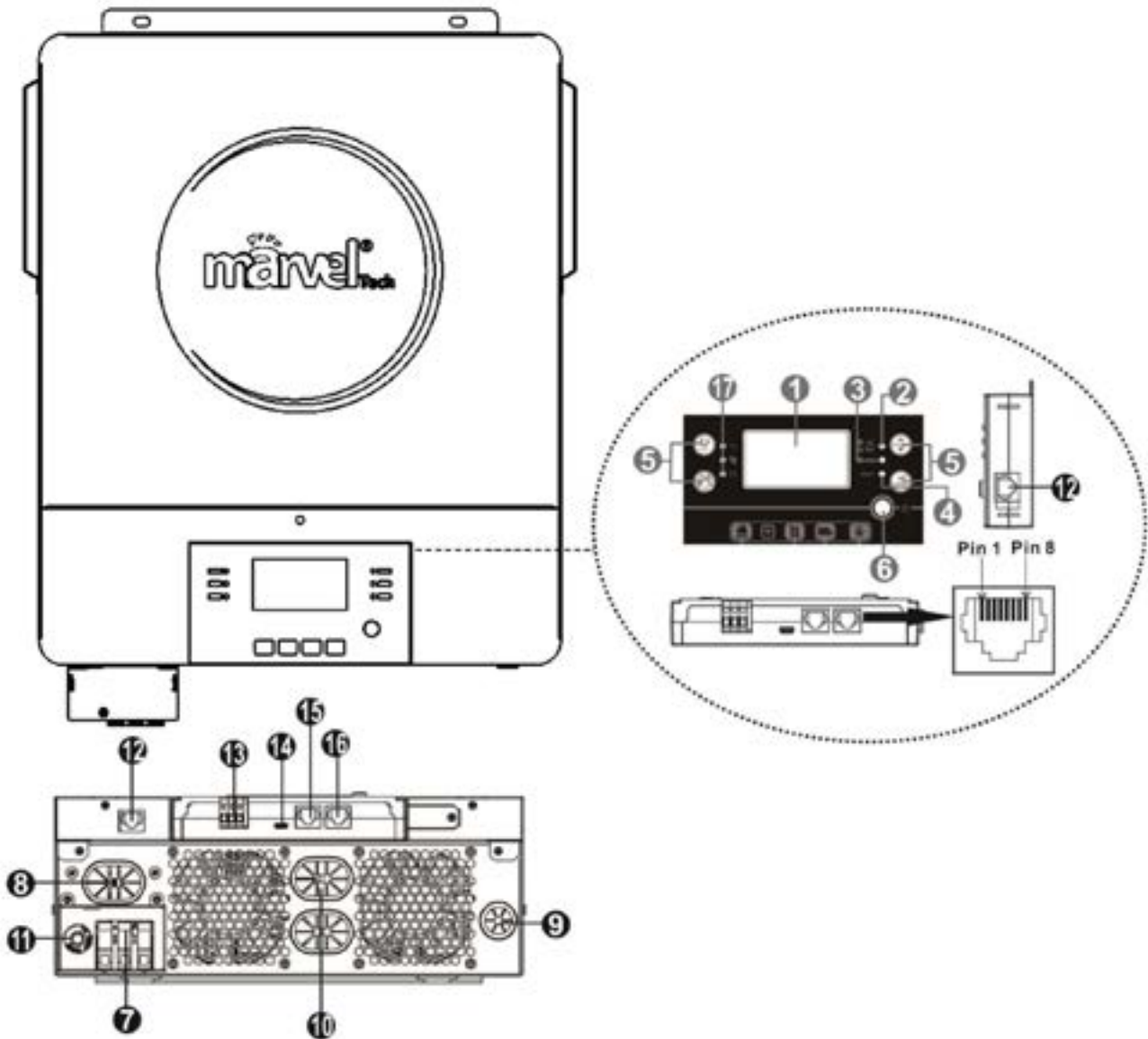

Figure 1 Hybrid Power System

Product Overview



1. LCD display
2. Status indicator
3. Charging indicator
4. Fault indicator
5. Function buttons
6. Power on/off switch
7. AC input connectors
8. AC output connectors (Load connection)
9. PV input
10. Battery input
11. Circuit breaker
12. Remote LCD panel communication port
13. Dry contact
14. USB communication port
15. BMS communication port: CAN and RS232 or RS485
16. RS-232 communication port
17. Output source indicators (refer to OPERATION/Operation and Display Panel section for details) and USB function setting reminder (refer to OPERATION/Function Setting for the details)

INSTALLATION

Unpacking and Inspection

Before installation, please inspect the content. Be sure that nothing inside the package is damaged. You should have received the following items inside the package:

- Inverter x 1
- User manual x 1
- RS232 Communication cable x 1
- Software CD x 1
- DC Fuse x 1

Preparation

Before connecting all wirings, please take off the bottom cover by removing two screws as shown below. Detach the cables from the cover.

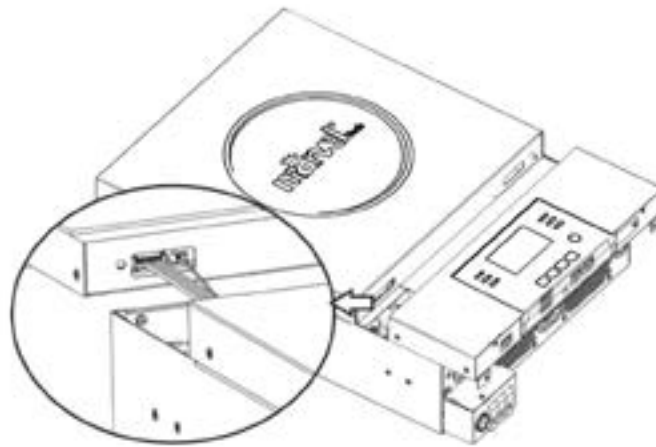

Mounting the Unit

Consider the followings before selecting your placements:

- Do not mount the inverter on flammable construction materials.
- Mount on a solid surface
- Install the inverter at eye level in order to allow easy LCD display readout.
- For proper air circulation and heat dissipation, allow a clearance of approx. 20 cm to the side and approx. 50 cm above and below the unit.
- The ambient temperature should be between 0°C and 55°C to ensure optimal operation.
- The recommended orientation is to be adhered to the wall vertically. Be sure to keep other objects and surfaces as shown in the diagram to guarantee sufficient heat dissipation and to have enough space for wirings.

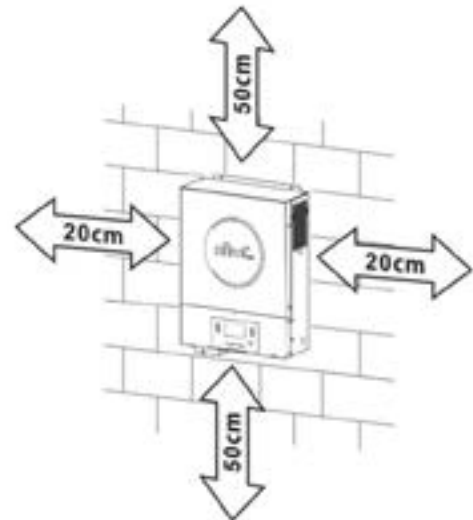

SUITABLE FOR MOUNTING ON CONCRETE OR OTHER NON-COMBUSTIBLE SURFACE ONLY.

Install the unit by screwing two screws. It's recommended to use M4 or M5 screws.

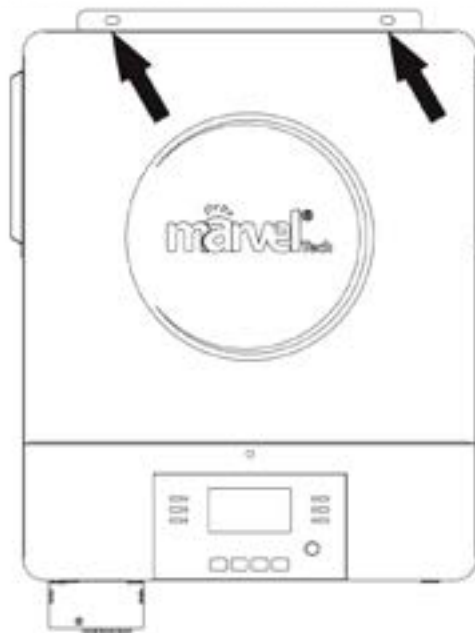

Battery Connection

CAUTION: For safety operation and regulation compliance, it's requested to install a separate DC over-current protector or disconnection device between battery and the inverter. It may not be necessary to have a disconnection device in some applications, however, it's still recommended to have over-current protection installed. Please refer to typical amperage as required.

WARNING! All wiring must be performed by a qualified electrical technician.

WARNING! It's very important for system safety and efficient operation to use appropriate cables for battery connection. To reduce risk of injury, please use the proper recommended cable in the table below.

Ring terminal:

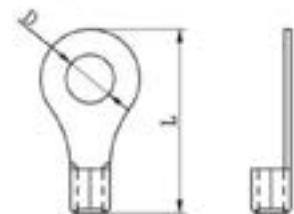

Recommended battery cable size:

Model	Typical Amperage	Wire Size	Cable mm ² (each)	Ring Terminal Dimensions		Torque Value
				D (mm)	L (mm)	
				4KW	165A	
6KW	124A	1*2AWG	38	8.4	39.2	
		2*4AWG	25	8.4	33.2	

Please follow below steps to implement battery connection:

1. 4KW model supports 24VDC system and 6KW model supports 48VDC system. Connect all battery packs as below chart. It is recommend to connect minimum of 100Ah capacity battery for 4KW model and 200Ah capacity battery for 6KW model.

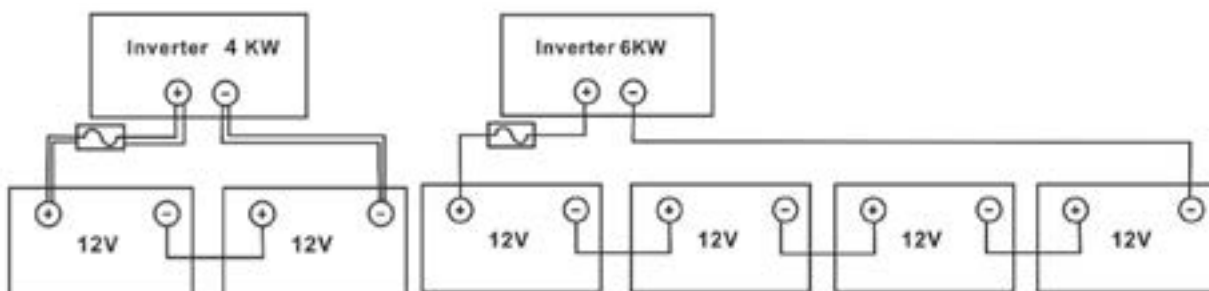

2. Prepare four battery wires for 4KW model and two or four battery wires for 6KW model depending on cable size (refer to recommended cable size table). Apply ring terminals to your battery wires and secure it to the battery terminal block with the bolts properly tightened. Refer to battery cable size for torque value. Make sure polarity at both the battery and the inverter is correctly connected and ring terminals are secured to the battery terminals.

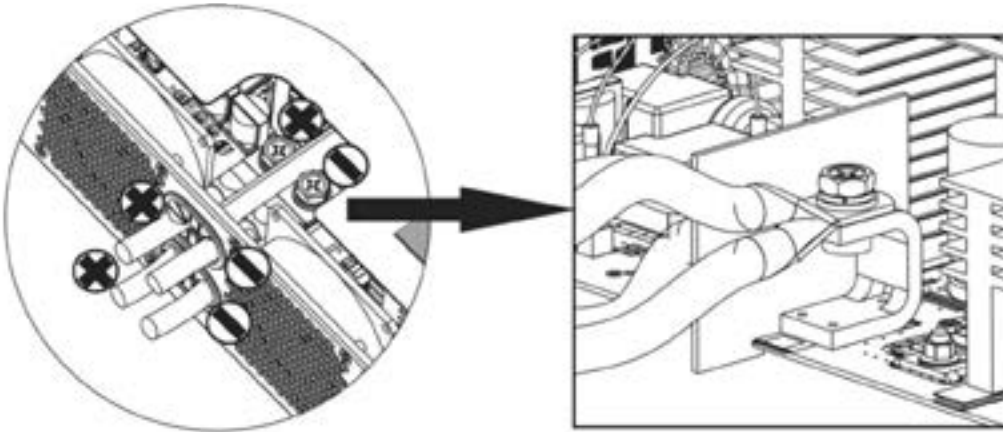

4KW / 6KW

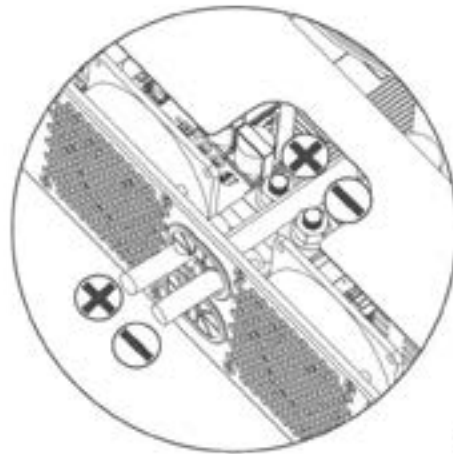

6KW



WARNING: Shock Hazard

Installation must be performed with care due to high battery voltage in series.



CAUTION!! Do not place anything between inverter terminals and the ring terminals. Otherwise, overheating may occur.

CAUTION!! Do not apply anti-oxidant substance on the terminals before terminals are securely tightened.

CAUTION!! Before making final DC connection or closing DC breaker/disconnector, be sure that the positive (+) must be connected to positive (+) and negative (-) connected to negative (-).

AC Input/Output Connection

CAUTION!! Before connecting to AC input power source, please install a **separate** AC breaker between the inverter and the AC input power source. This will ensure that the inverter can be safely disconnected during maintenance and fully protected from over-current. The recommended spec of AC breaker is 32A

CAUTION!! There are two power terminal blocks with "IN" (Input) and "OUT" (Output) markings. DO NOT mistakenly connect to the wrong connectors.

WARNING! All wiring must be performed by a qualified personnel.

WARNING! It's very important for system safety and efficient operation to use appropriate cable size for AC input connection. To reduce risk of injury, please use the proper recommended cable size as below.

Suggested cable requirement for AC wires

Model	Gauge	Cable (mm ²)	Torque Value
4KW	12 AWG	4	1.2 Nm
6KW	10 AWG	6	1.2 Nm

Please follow these steps to implement AC input/output connection:

1. Before making AC input/output connection, be sure to enable DC protector or disconnecter first.
2. Remove insulation sleeves for about 10mm for the five screw terminals.
3. Insert AC input wires according to polarities indicated on terminal block and tighten the terminal screws. Be sure to connect the grounding wire (⊕) first.

⊕→**Ground (yellow-green)**

L→**LINE (brown or black)**

N→**Neutral (blue)**

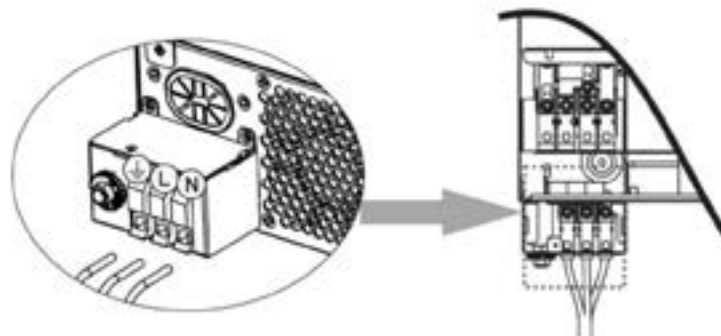

WARNING:

Be sure that AC power source is disconnected before attempting to hardwire it to the unit.

4. This inverter is equipped with dual-output. There are four terminals (L1/N1, L2/N2) available on output port. It's set up through LCD program or monitoring software to turn on and off the second output. Refer to "LCD setting" section for the details.

Insert AC output wires according to polarities indicated on terminal block and tighten terminal screws. Be sure to connect PE protective conductor (⊕) first.

⊕→**Ground (yellow-green)**

L1→**LINE (brown or black)**

N1→**Neutral (blue)**

L2→**LINE (brown or black)**

N2→**Neutral (blue)**

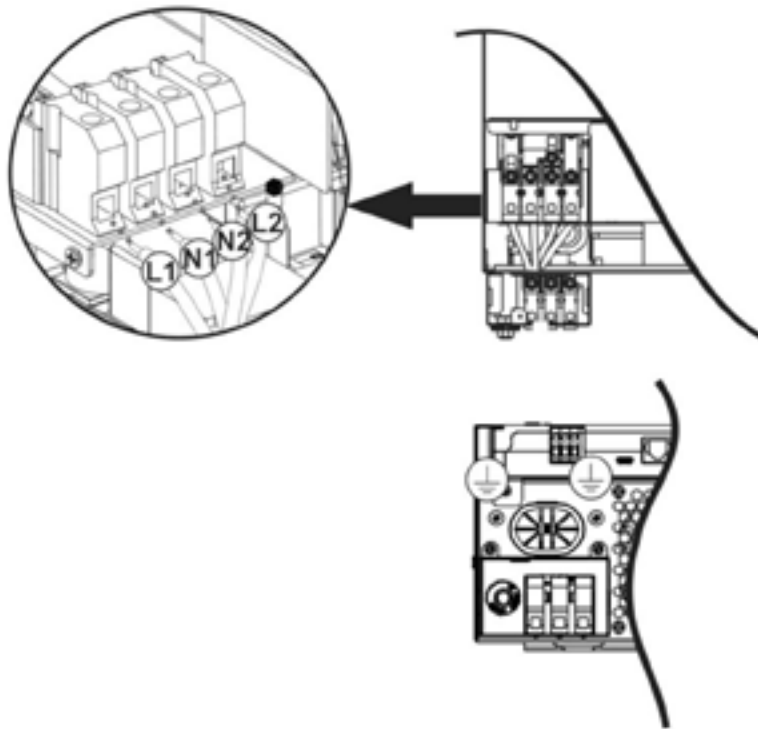

5. Make sure the wires are securely connected.

CAUTION: Appliances such as air conditioner required at least 2~3 minutes to spool up because it needs to have enough time to balance refrigerant gas inside of circuits. If a power shortage occurs and recovers in a short period of time, it may cause damage to your connected appliances. To prevent this from happening, please check with manufacturer of air conditioner if it has time-delay function before installation. Otherwise, this inverter will trigger overload fault and cut off output to protect your appliance but sometimes it may still causes damage to the air conditioner.

PV Connection

CAUTION: Before connecting to PV modules, please install a **separately** DC circuit breaker between the inverter and PV modules.

WARNING! It's very important for system safety and efficient operation to use appropriate cable for PV module connection. To reduce risk of injury, please use the proper recommended cable size shown below.

Model	Wire Size	Cable (mm ²)	Torque value (max)
4KW/6KW	1 x 12AWG	4	1.2 Nm

WARNING: Because this inverter is non-isolated, are accepted: single crystalline, poly crystalline with class A-rated and CIGS modules. To avoid any malfunctions, do not connect any PV modules with possible current leakage to the inverter. For example, grounded PV modules will cause current leakage to the inverter. When using CIGS modules, please be sure NO grounding connection.

CAUTION: It's requested to use PV junction box with surge protection. Otherwise, it will cause damage on inverter when lightning occurs on PV modules.

PV Module Selection:

When selecting proper PV modules, please be sure to consider the following parameters:

1. Open circuit Voltage (Voc) of PV modules not to exceeds maximum PV array open circuit voltage of the inverter.

2. Open circuit Voltage (Voc) of PV modules should be higher than the start-up voltage.

INVERTER MODEL	4KW	6KW
Max. PV Array Power	5000W	6000W
Max. PV Array Open Circuit Voltage	500Vdc	
PV Array MPPT Voltage Range	60Vdc~450Vdc	
Start-up Voltage	60Vdc +/- 10Vdc	
Max. PV Current	27A	

Take the 250Wp PV module as an example. After considering above two parameters, the recommended module configurations are listed in the table below.

Solar Panel Spec. (reference) - 250Wp - Vmp: 30.1Vdc - Imp: 8.3A - Voc: 37.7Vdc - Isc: 8.4A - Cells: 60	SOLAR INPUT		Q'ty of panels	Total input power
	Min in series: 2 pcs, max. in series: 12 pcs.			
	2pcs in series		2 pcs	500W
	4pcs in series		4 pcs	1000W
	6 pcs in series		6 pcs	1500W
	8 pcs in series		8 pcs	2000W
	12 pcs in series		12 pcs	3000W
	8 pieces in series and 2 sets in parallel		16 pcs	4000W
	10 pieces in series and 2 sets in parallel		20 pcs	5000W
	11 pieces in series and 2 sets in parallel (only for 6KVA model)		22 pcs	5500W
	12 pieces in series and 2 sets in parallel (only for 6KVA model)		24 pcs	6000W

Take the 555Wp PV module as an example. After considering above two parameters, the recommended module configurations are listed in the table below.

Solar Panel Spec. (reference) - 555Wp - Imp: 17.32A - Voc: 38.46Vdc - Isc: 18.33A - Cells: 110	SOLAR INPUT		Q'ty of panels	Total input power
	Min in series: 2 pcs, max. in series: 11 pcs.			
	2pcs in series		2 pcs	1110W
	4pcs in series		4 pcs	2220W
	6 pcs in series		6 pcs	3330W
	8 pcs in series		8 pcs	4440W
	10 pcs in series (only for 6KVA model)		10 pcs	5550W
	11 pcs in series (only for 6KVA model)		11 pcs	6000W

PV Module Wire Connection

Please take the following to implement PV module connection:

1. Remove insulation sleeve for about 7 mm on your positive and negative wires.
2. We recommend using bootlace ferrules on the wires for optimal performance.
3. Check polarities of wire connections from PV modules to PV input screw terminals. Connect your wires as illustrated below.

Recommended tool: 4mm blade screwdriver

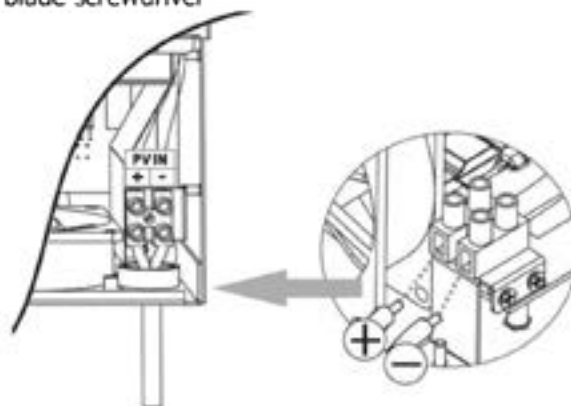

Final Assembly

After connecting all wirings, replace the bottom cover as shown below.

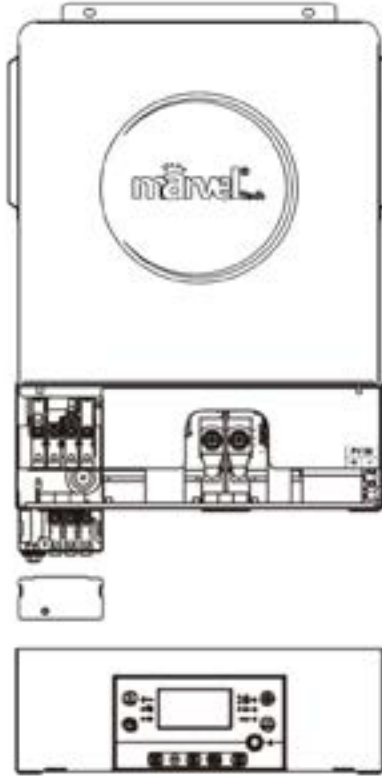

Remote Display Panel Installation

The LCD module can be removable and installed in a remote location with an optional communication cable. Please take the follow steps to implement this remote panel installation.

Step 1. Remove the screw on the bottom of LCD panel and pull down the module from the case. Detach the cable from the remote communication port. Be sure to replace the retention plate back to the inverter.

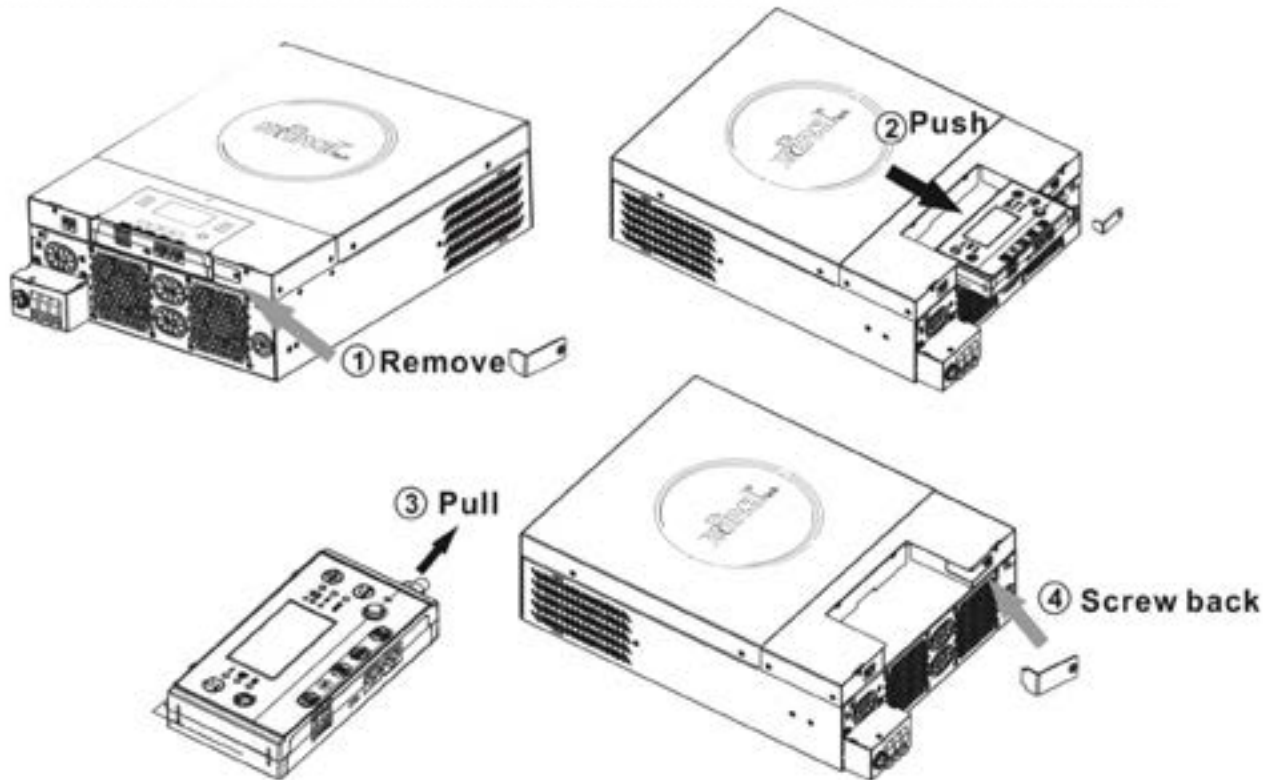

Step 2. Prepare your mounting holes in the marked locations as shown in the illustration below. The LCD module then can be securely mounted to your desired location.

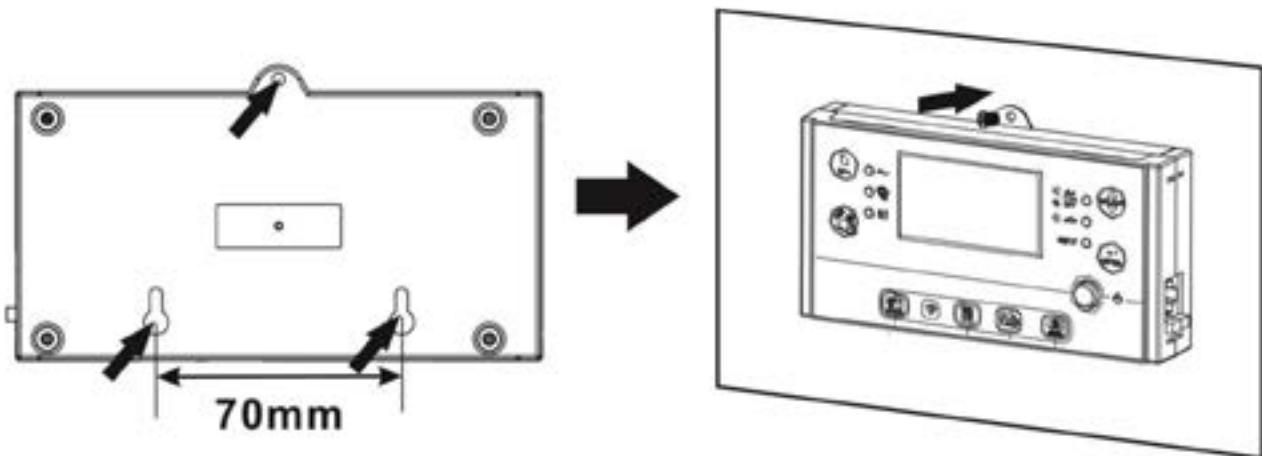

Note: Wall installation should be implemented with the proper screws to the right.



Step 3. Connect LCD module to the inverter with an optional RJ45 communication cable as shown below.

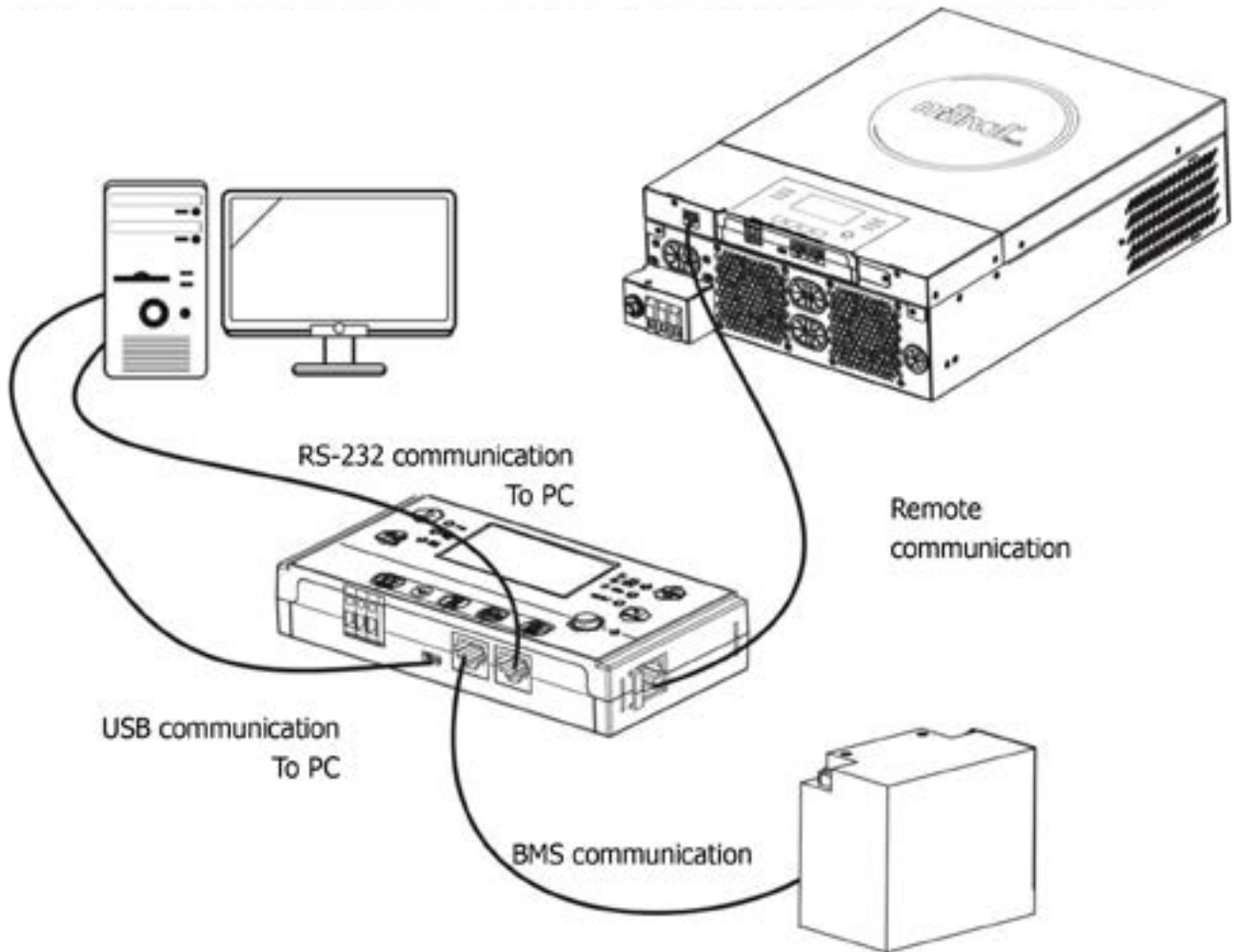

Communication Options

Serial Connection

Please use the supplied serial cable to connect between the inverter and your PC. Install the monitoring software from the bundled CD and follow the on-screen instructions to complete your installation. For detailed software operation, refer to the software user manual on the bundled CD.

BMS Communication

It is recommended to purchase a special communication cable if you are connecting to Lithium-Ion battery banks. Please refer to Appendix B- BMS Communication Installation for details.

Dry Contact Signal

There is one dry contact (3A/250VAC) available on the rear panel. It could be used to deliver signal to external device when battery voltage reaches warning level.

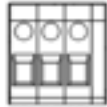
Unit Status	Condition		Dry contact port: 		
			NC & C	NO & C	
Power Off	Unit is off and no output is powered.		Close	Open	
Power On	Output is powered from Battery power or Solar energy.	Program 01 set as USB (utility first)	Battery voltage < Low DC warning voltage	Open	Close
			Battery voltage > Setting value in Program 13 or battery charging reaches floating stage	Close	Open
		Program 01 is set as SBU (SBU priority)	Battery voltage < Setting value in Program 12	Open	Close
			Battery voltage > Setting value in Program 13 or battery charging reaches floating stage	Close	Open

OPERATION

Power ON/OFF

Once the unit has been properly installed and the batteries are connected well, simply press On/Off switch (located on the display panel) to turn on the unit.



Inverter Turn-on

After this inverter is turned on, WELCOME light show will be started with RGB LED BAR. It will slowly cycle through entire spectrum of nine colors (Green, Sky blue, Royal blue, Violet, Pink, Red, Honey, Yellow, Lime yellow) about 10-15 seconds. After initialization, it will light up with default color.

RGB LED BAR can light up in different color and light effects based on the setting of energy priority to display the operation mode, energy source, battery capacity and load level. These parameters such as color, effects, brightness, speed and so on can be configured through the LCD panel. Please refer to LCD settings for the details.

Operation and Display Panel



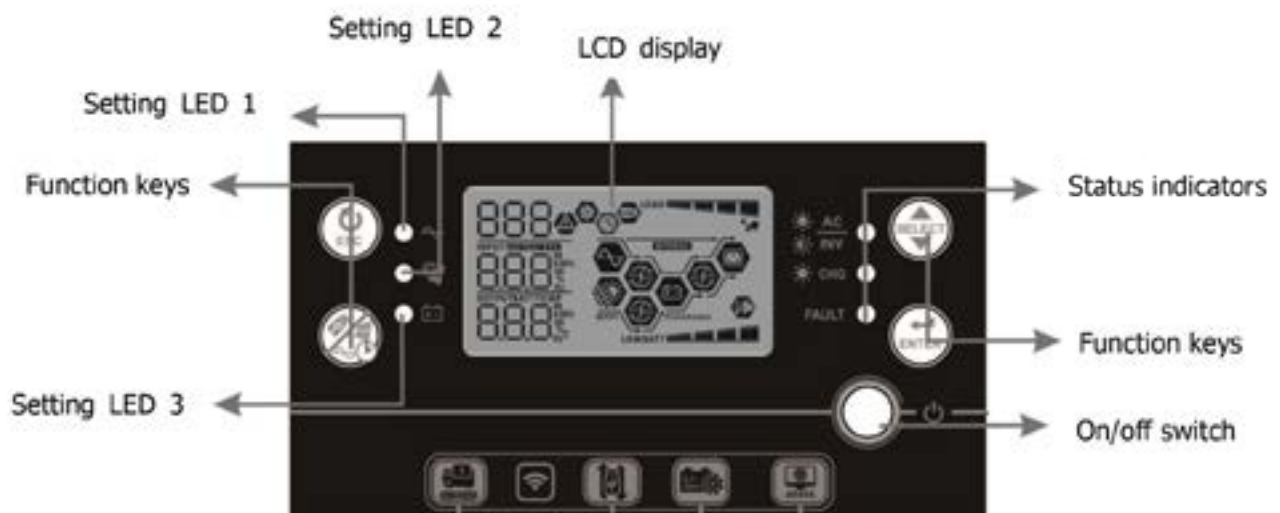

The operation and the LCD module, shown in the chart below, includes six indicators, six function keys, on/off switch and a LCD display, indicating the operating status and input/output power information.



Indicators

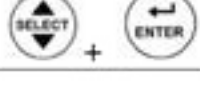

LED Indicator	Color	Solid/Flashing	Messages	
Setting LED 1	Green	Solid On	Output powered by utility	
Setting LED 2	Green	Solid On	Output powered by PV	
Setting LED 3	Green	Solid On	Output powered by battery	
Status indicators		Green	Solid On	Output is available in line mode
		Green	Flashing	Output is powered by battery in battery mode
	Green	Solid On	Battery is fully charged	
		Flashing	Battery is charging.	
	Red	Solid On	Fault mode	
Flashing		Warning mode		

Function Keys

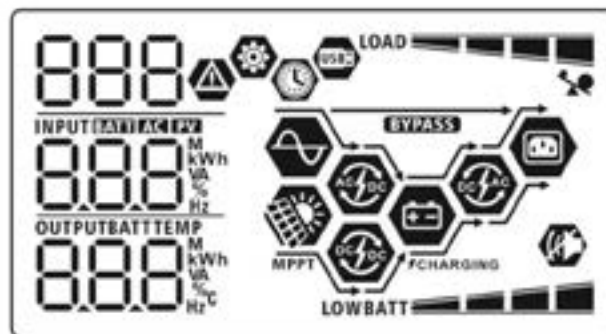

Function Key	Description
	ESC Exit the setting
	USB function setting Select USB OTG functions
	Timer setting for the Output source priority Setup the timer for prioritizing the output source
	Timer setting for the Charger source priority Setup the timer for prioritizing the charger source
	Select To next selection
	Enter To confirm/enter the selection in setting mode
	Press these two keys at the time to switch RGB LED bar for output source priority and battery discharge/charge status

LCD Display Icons



Icon	Function description
Input Source Information	
	Indicates the AC input.
	Indicates the PV input
	Indicate input voltage, input frequency, PV voltage, charger current, charger power, battery voltage.

Configuration Program and Fault Information

	Indicates the setting programs.
888	
888 	Indicates the warning and fault codes. Warning: 88  flashing with warning code. Fault: F88 lighting with fault code

Output Information

OUTPUT BATT TEMP 88.8 AC VOLT Hz LOAD % VA W A	Indicate output voltage, output frequency, load percent, load in VA, load in Watt and discharging current.
OUTPUT	The ICON flashing that indicate the unit with AC output and setting Programs 60, 61 or 62 different to default setting.









Battery Information

BATT 	Indicates battery level by 0-24%, 25-49%, 50-74% and 75-100% in battery mode and charging status in line mode.
--	--







When battery is charging, it will present battery charging status.









Status	Battery voltage	LCD Display
Constant Current mode / Constant Voltage mode	< 2V/cell	4 bars will flash in turns.
	2 ~ 2.083V/cell	The right bar will be on and the other three bars will flash in turns.
	2.083 ~ 2.167V/cell	The right two bars will be on and the other two bars will flash in turns.
	> 2.167 V/cell	The right three bars will be on and the left bar will flash.
Floating mode. Batteries are fully charged.		4 bars will be on.

In battery mode, it will present battery capacity.

Load Percentage	Battery Voltage	LCD Display
Load > 50%	< 1.85V/cell	LOW BATT 
	1.85V/cell ~ 1.933V/cell	BATT 
	1.933V/cell ~ 2.017V/cell	BATT 
	> 2.017V/cell	BATT 
Load < 50%	< 1.892V/cell	LOW BATT 
	1.892V/cell ~ 1.975V/cell	BATT 
	1.975V/cell ~ 2.058V/cell	BATT 
	> 2.058V/cell	BATT 

Load Information

	Indicates overload.	
LOAD  	Indicates the load level by 0-24%, 25-49%, 50-74% and 75-100%.	
	0%~24%	25%~49%
	LOAD 	LOAD 
	50%~74%	75%~100%
	LOAD 	LOAD 





Mode Operation Information	
	Indicates unit connects to the mains.
 MPPT	Indicates unit connects to the PV panel.
	Indicates load is supplied by utility power.
	Indicates the utility charger circuit is working.
	Indicates the solar charger circuit is working.
	Indicates the DC/AC inverter circuit is working.
	Indicates unit alarm is disabled.
	Indicates USB disk is connected.
	Indicates timer setting or time display

LCD Setting













General Setting









After pressing and holding "ENTER" button for 3 seconds, the unit will enter the Setup Mode. Press "SELECT" button to select setting programs. Press "ENTER" button to confirm you selection or "ESC" button to exit.







Setting Programs:











Program	Description	Selectable option	
00	Exit setting mode	Escape 00  ESC	
01	Output source priority: To configure load power source priority	Utility first (default) 01  USb	Utility will provide power to the loads as first priority. Solar and battery energy will provide power to the loads only when utility power is not available.
		Solar first 01  SUb	Solar energy provides power to the loads as first priority. If solar energy is not sufficient to power all connected loads, Utility energy will supply power to the loads at the same time.
		SBU priority 01  SbU	Solar energy provides power to the loads as first priority. If solar energy is not sufficient to power all connected loads, battery energy will supply power to the loads at the same time. Utility provides power to the loads only when battery voltage drops to either low-level warning voltage or the setting point in program 12.
02	Maximum charging current: To configure total charging current for solar and utility chargers. (Max. charging current = utility charging current + solar charging current)	60A (default) 02  60 ^A	Setting range is from 10A to 120A. Increment of each click is 10A.





03	AC input voltage range	Appliances (default) 03	If selected, acceptable AC input voltage range will be within 90-280VAC.
		APl UPS 03	If selected, acceptable AC input voltage range will be within 170-280VAC.
05	Battery type	AGM (default) 05	Flooded 05
		AGn User-Defined 05	If "User-Defined" is selected, battery charge voltage and low DC cut-off voltage can be set up in program 26, 27 and 29.
		USE Pylontech battery 05	If selected, programs of 02, 26, 27 and 29 will be automatically set up. No need for further setting.
		PYL WECO battery (only for 48V model) 05	If selected, programs of 02, 12, 26, 27 and 29 will be auto-configured per battery supplier recommended. No need for further adjustment.
		WEC Soltaro battery (only for 48V model) 05	If selected, programs of 02, 26, 27 and 29 will be automatically set up. No need for further setting.
		SOL	

		LiB-protocol compatible battery 05  LiB	Select "LiB" if using Lithium battery compatible to Lib protocol. If selected, programs of 02, 26, 27 and 29 will be automatically set up. No need for further setting.
		3 rd party Lithium battery 05  LiC	Select "LiC" if using Lithium battery not listed above. If selected, programs of 02, 26, 27 and 29 will be automatically set up. No need for further setting. Please contact the battery supplier for installation procedure.
06	Auto restart when overload occurs	Restart disable (default) 06  Lfd	Restart enable 06  LfE
07	Auto restart when over temperature occurs	Restart disable (default) 07  tfd	Restart enable 07  tFE
09	Output frequency	50Hz (default) 09  50.	60Hz 09  60.
10	Output voltage	220V 10  220.	230V (default) 10  230.
		240V 10  240.	
11	Maximum utility charging current Note: If setting value in program 02 is smaller than that in program in 11, the inverter will apply charging current from program 02 for utility charger.	30A (default) 11  Uti 30.	Setting range is 2A, then from 10A to 100A. Increment of each click is 10A.

12	Setting voltage or SOC percentage back to utility source when selecting "SBU" (SBU priority) in program 01.	23V (default for 24V model) 12  BATT 23.0V	Setting range is from 22V to 25.5V. Increment of each click is 0.5V.
		46V (default for 48V model) 12  BATT 46.0V	Setting range is from 44V to 55V. Increment of each click is 1V.
		SOC 10% (default for Lithium) 12  SOC BATT 10%	If any types of lithium battery is selected in program 05, setting value will change to SOC automatically. Adjustable range is 5% to 95%.
13	Setting voltage or SOC percentage back to battery mode when selecting "SBU" (SBU priority) in program 01.	Available options for 24V model: Setting range is FUL and from 24V to 29V. Increment of each click is 1V.	
		Battery fully charged 13  BATT FUL V	27V (default) 13  BATT 27.0V
		Available options for 48V model: Setting range is FUL and from 48V to 58V. Increment of each click is 1V.	
		Battery fully charged 13  BATT FUL V	54V (default) 13  BATT 54V
SOC 30% (default for Lithium) 13  SOC BATT 30%		If any types of lithium battery is selected in program 05, setting value will change to SOC automatically. Adjustable range is 10% to 100%. Increment of each click is 5%.	

16	Charger source priority: To configure charger source priority	If this inverter/charger is working in Line, Standby or Fault mode, charger source can be programmed as below:	
		Solar first 16 	Solar energy will charge battery as first priority. Utility will charge battery only when solar energy is not available.
		C50	
		Solar and Utility (default) 16 	Solar energy and utility will charge battery at the same time.
		SNU	
18	Alarm control	Alarm on (default) 18 	Alarm off 18 
		b0n	b0f
19	Auto return to default display screen	Return to default display screen (default) 19 	If selected, no matter how users switch display screen, it will automatically return to default display screen (Input voltage /output voltage) after no button is pressed for 1 minute.
		ESP	
		Stay at latest screen 19 	If selected, the display screen will stay at latest screen user finally switches.
		1EP	



20	Backlight control	Backlight on (default) 20  LON	Backlight off 20  LOF
22	Beeps while primary source is interrupted	Alarm on (default) 22  AON	Alarm off 22  AOF
23	Overload bypass: When enabled, the unit will transfer to line mode if overload occurs in battery mode.	Bypass disable (default) 23  byd	Bypass enable 23  byE
25	Record Fault code	Record enable (default) 25  FEN	Record disable 25  FdS
26	Bulk charging voltage (C.V voltage)	Available options for 24V model:	
		28.2V (default) 26  CU BATT 28.2 _V	If user-defined is selected in program 5, this program can be set up. Setting range is from 25.0V to 31.5V. Increment of each click is 0.1V.
		Available options for 48V model:	
		56.4V (default) 26  CU BATT 56.4 _V	If user-defined is selected in program 5, this program can be set up. Setting range is from 48.0V to 61.0V. Increment of each click is 0.1V.

27	Floating charging voltage	Available options for 24V model:	
		27V (default) 	If user-defined is selected in program 5, this program can be set up. Setting range is from 25.0V to 31.5V. Increment of each click is 0.1V.
		Available options for 48V model:	
		54V (default) 	If user-defined is selected in program 5, this program can be set up. Setting range is from 48.0V to 61.0V. Increment of each click is 0.1V.
29	Low DC cut-off voltage or SOC percentage: <ul style="list-style-type: none"> ● If battery power is only power source available, inverter will shut down. ● If PV energy and battery power are available, inverter will charge battery without AC output. ● If PV energy, battery power and utility are all available, inverter will transfer to line mode 	Available options for 24V model:	
		21.0V (default) 	If user-defined is selected in program 5, this program can be set up. Setting range is from 21.0V to 24.0V. Increment of each click is 0.1V. Low DC cut-off voltage will be fixed to setting value no matter what percentage of load is connected.
		Available options for 48V model:	
		42.0V (default) 	If user-defined is selected in program 5, this program can be set up. Setting range is from 42.0V to 48.0V. Increment of each click is 0.1V. Low DC cut-off voltage will be fixed to setting value no matter what percentage of load is connected.
		SOC 0% (default) 	If Lithium battery is selected in program 5, setting value will change to SOC automatically. Setting range is from 0% to 90%.

30	Battery equalization	Battery equalization 30	Battery equalization disable (default) 30
		EEN	EdS
If "Flooded" or "User-Defined" is selected in program 05, this program can be set up.			
31	Battery equalization voltage	Available options for 24V model:	
		29.2V (default) 31 EV BATT 29.2V	Setting range is from 25.0V to 31.5V. Increment of each click is 0.1V.
		Available options for 48V model:	
		58.4V (default) 31 EV BATT 58.4V	Setting range is from 48.0V to 61.0V. Increment of each click is 0.1V.
33	Battery equalized time	60min (default) 33 60	Setting range is from 5min to 900min. Increment of each click is 5min.
34	Battery equalized timeout	120min (default) 34 120	Setting range is from 5min to 900 min. Increment of each click is 5 min.
35	Equalization interval	30days (default) 35 30d	Setting range is from 0 to 90 days. Increment of each click is 1 day
36	Equalization activated immediately	Enable 36 AEN	Disable (default) 36 AdS



		<p>If equalization function is enabled in program 30, this program can be set up. If "Enable" is selected in this program, it's to activate battery equalization immediately and LCD main page will shows "E9". If "Disable" is selected, it will cancel equalization function until next activated equalization time arrives based on program 35 setting. At this time, "E9" will not be shown in LCD main page.</p>	
37	Reset all stored data for PV generated power and output load energy	<p>Not reset(Default)</p> <p>37 </p> <p>ntt</p>	<p>Reset</p> <p>37 </p> <p>tst</p>
60	Low DC cut off voltage or SOC percentage on second output	<p>24V default setting: 21.0V</p> <p>60 </p> <hr/> <p>BATT</p> <p>21.0V</p>	<p>If "User-defined" is selected in program 05, this setting range is from 21.0V to 31.5V for 24V model. Increment of each click is 0.1V.</p>
		<p>48V default setting: 42.0V</p> <p>60 </p> <hr/> <p>BATT</p> <p>42.0V</p>	<p>If "User-defined" is selected in program 05, this setting range is from 42.0V to 61.0V for 48V model. Increment of each click is 0.1V.</p>
		<p>SOC 0% (default for Lithium)</p> <p>60 </p> <p>SOC</p> <p>BATT</p> <p>0%</p>	<p>If any type of lithium battery is selected in program 05, this parameter value will be displayed in percentage and value setting is based on battery capacity percentage. Setting range is from 0% to 95%. Increment of each click is 5%.</p>
61	Setting discharge time on the second output (L2)	<p>Disable (Default)</p> <p>61 </p> <p>dds</p>	<p>Setting range is disable and then from 0 min to 990 min. Increment of each click is 5 min.</p> <p>*If the battery discharge time achieves the setting time in program 61 and the program 60 function is not triggered, the output will be turned off.</p>

62	Setting time interval to turn on second output (L2)	00~23 (Default. Second output is always on) 62 0 23	Setting range is from 00 to 23. Increment of each click is 1 hour. If setting range is from 00 to 08, the second output will be turned on until 09:00. During this period, it will be turned off if any setting value in program 60 or 61 is reached.
93	Erase all data log	Not reset(Default) 93 nft	Reset 93 tst
94	Data log recorded interval *The maximum data log number is 1440. If it's over 1440, it will re-write the first log.	3 minutes 94 3	5 minutes 94 5
		10 minutes (default) 94 10	20 minutes 94 20
		30 minutes 94 30	60 minutes 94 60
95	Time setting – Minute	For minute setting, the range is from 0 to 59. 95 ntn 0	
96	Time setting – Hour	For hour setting, the range is from 0 to 23. 96 hou 0	







97	Time setting- Day	For day setting, the range is from 1 to 31. 
98	Time setting- Month	For month setting, the range is from 1 to 12. 
99	Time setting - Year	For year setting, the range is from 17 to 99. 

Functional Setting







There are three function settings: USB OTG, timer setting for output source priority and timer setting for charger source priority.





Insert an OTG USB disk into the USB port () . Press and hold "" button for 3 seconds to enter USB Setup Mode. These functions including inverter firmware upgrade, data log export and internal parameters re-write from the USB disk.

1. USB Function Setting

Procedure	LCD Screen
Step 1: Press and hold "  " button for 3 seconds to enter Function Setting mode.	UPG  
Step 2: Press "  ", "  " or "  " button to enter the selectable setting programs	SET LOG

Step 3: Please select setting program by following the procedure.

Program #	Operation Procedure	LCD Screen
 : Upgrade firmware	This function is to upgrade inverter firmware. If firmware upgrade is needed, please check with your dealer or installer for detail instructions.	
 : Re-write internal parameters	This function is to over-write all parameter settings (TEXT file) with settings in the On-The-Go USB disk from a previous setup or to duplicate inverter settings. Please check with your dealer or installer for detail instructions.	
 : Export data log	Press "  " button to export data log from USB disk to inverter. If the selected function is ready, LCD will display "LOG". Press "  " button to confirm the selection again.	LOG   LOG

	<ul style="list-style-type: none"> Press " " button to select "Yes", LED 1 will flash once every second during the process. It will only display LOG and all LEDs will be on after this action is complete. Then, press " " button to return to main screen. Or press " " button to select "No" to return to main screen. 	
--	---	---

If no button is pressed for 1 minute, it will automatically return to main screen.







Error message for USB On-The-Go functions:

Error Code	Messages
U01	No USB disk is detected.
U02	USB disk is protected from copying.
U03	Document inside the USB disk contains the wrong format.

















If any error occurs, error code will only show for 3 seconds. After 3 seconds, it will automatically return to the main screen.







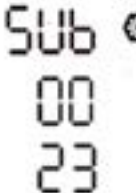

2. Timer Setting for Output Source Priority

This timer setting is to set up the output source priority per day.

Procedure	LCD Screen
Step 1: Press and hold "  " button for 3 seconds to enter Function Setting Mode for output source priority.	
Step 2: Press "  ", "  " or "  " button to enter the selectable setting programs (detail descriptions in Step 3).	

Step 3: Please select setting program by following each procedure.

Program#	Operation Procedure	LCD Screen
	Press "  " button to set up Utility First Timer. Press "  " button to select starting time. Press "  " button to adjust values and press "  " to confirm. Press "  " button again to select end time. Press "  " button to adjust values, press "  " button to confirm. The setting values are from 00 to 23, with 1-hour increment.	
	Press "  " button to set up Solar First Timer. Press "  " button to select starting time. Press "  " button to adjust values and press "  " to confirm. Press "  " button to select end time. Press "  " button to adjust values, press "  " button to confirm. The setting values are from 00 to 23, with 1-hour increment.	





	<p>Press "</p> " button to set up SBU Priority Timer. Press "  " button to select starting time. Press "  " button to adjust values and press "  " to confirm. Press "  " button to select end time. Press "  " button to adjust values, press "  " button to confirm. The setting values are from 00 to 23, with 1-hour increment.	
---	---	---

Press "



























" button to exit the Setup Mode.

3. Timer Setting for the Charger Source Priority

This timer setting is to set up the charger source priority per day.

Procedure	LCD Screen
<p>Step 1: Press and hold "</p> " button for 3 seconds to enter Timer Setup Mode for charging source priority.	
<p>Step 2: Press "</p> ", "  " or "  " button to enter the selectable programs (detail descriptions in Step 3).	

Step 3: Please select setting program by following each procedure.

Program #	Operation Procedure	LCD Screen
	<p>Press "</p> " button to set up Solar First Timer. Press "  " button to select starting time. Press "  " button to adjust values and press "  " to confirm. Press "  " button to select end time. Press "  " button to adjust values and press "  " button to confirm. The setting values are from 00 to 23, with 1-hour increment.	
	<p>Press "</p> " button to set up Solar & Utility Timer. Press "  " button to select starting time. Press "  " button to adjust values and press "  " to confirm. Press "  " button to select end time. Press "  " button to adjust values, press "  " button to confirm. The setting values are from 00 to 23, with 1-hour increment.	
	<p>Press "</p> " button to set up Solar Only Timer. Press "  " button to select starting time. Press "  " button to adjust values and press "  " to confirm. Press "  " button to select end time. Press "  " button to adjust values, press "  " button to confirm. The setting values are from 00 to 23, with 1-hour increment.	



Press "ESC" button to exit the Setup Mode.

Display Setting



The LCD display information will be switched in turn by pressing the "SELECT" button. The selective information is switched as the following table in order:

Selectable information	LCD display
Input voltage/Output voltage (Default Display Screen)	<p>Input Voltage=230V, output voltage=230V</p>
Input frequency	<p>Input frequency=50Hz</p>
PV voltage	<p>PV voltage=260V</p>
PV current	<p>PV current = 2.5A</p>
PV power	<p>PV power = 500W</p>

Charging current

AC and PV charging current=50A

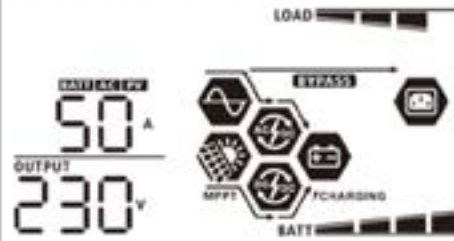

PV charging current=50A

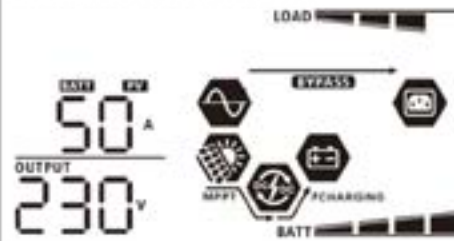

AC charging current=50A

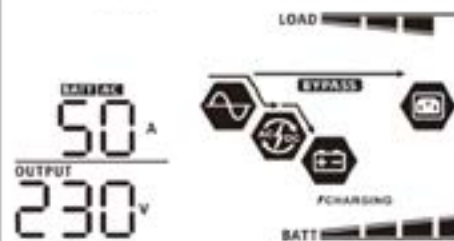

Charging power

AC and PV charging power=500W

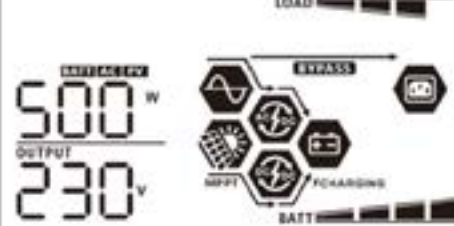

PV charging power=500W

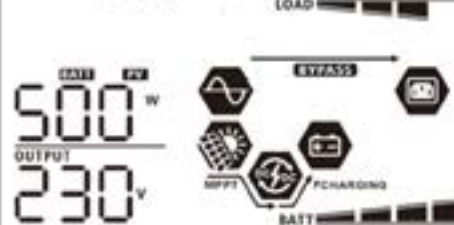



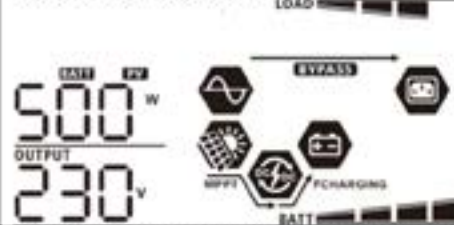

AC charging power=500W



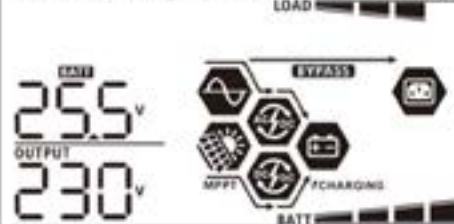



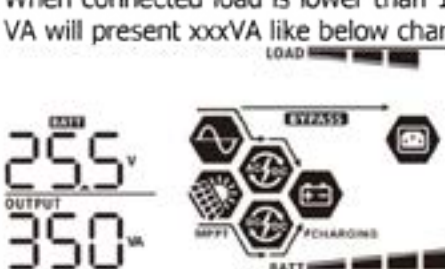
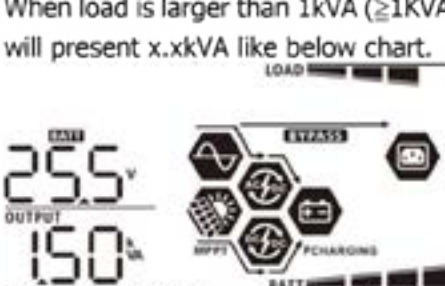
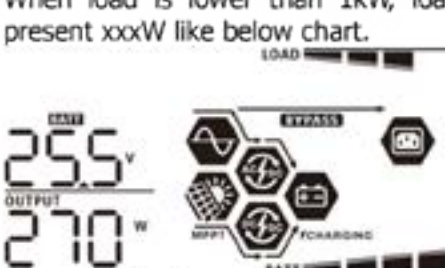

Battery voltage and output voltage

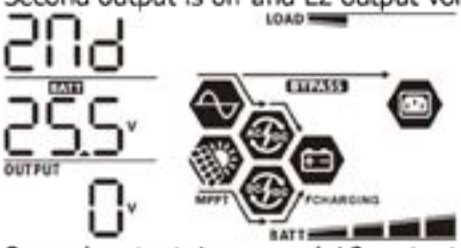
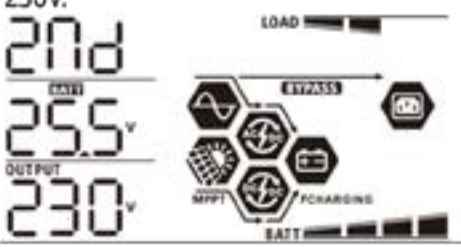
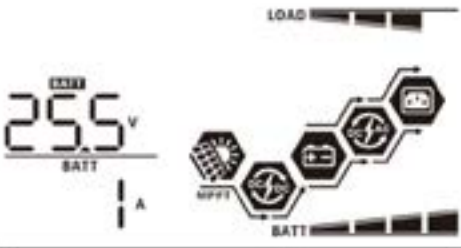
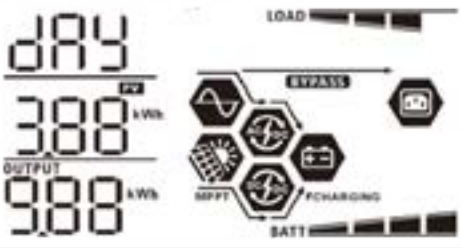
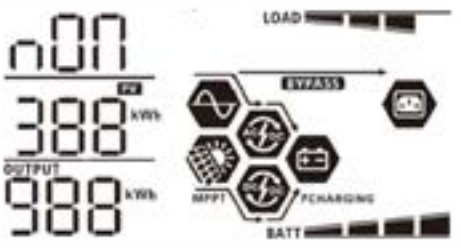
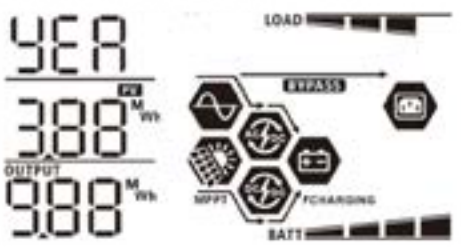
Battery voltage=25.5V, output voltage=230V

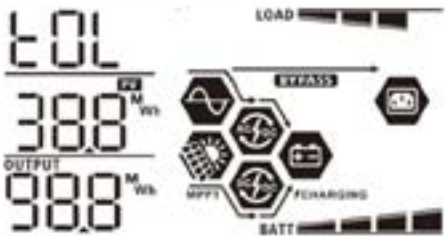











Output frequency	<p>Output frequency=50Hz</p> 
Load percentage	<p>Load percent=70%</p> 
Load in VA	<p>When connected load is lower than 1kVA, load in VA will present xxxVA like below chart.</p>  <p>When load is larger than 1kVA ($\geq 1\text{kVA}$), load in VA will present x.xkVA like below chart.</p> 
Load in Watt	<p>When load is lower than 1kW, load in W will present xxxW like below chart.</p>  <p>When load is larger than 1kW ($\geq 1\text{kW}$), load in W will present x.xkW like below chart.</p> 



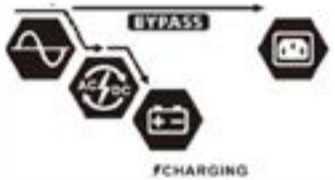
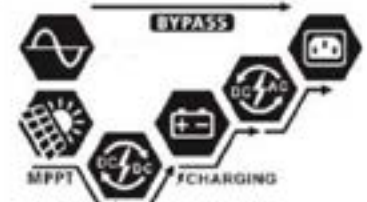
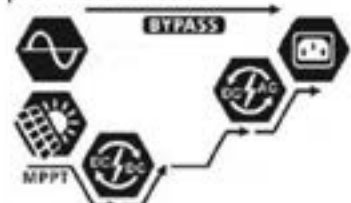

<p>L2 output voltage</p>	<p>Second output is off and L2 output voltage is 0V.</p>  <p>Second output is on and L2 output voltage is 230V.</p> 
<p>Battery voltage/DC discharging current</p>	<p>Battery voltage=25.5V, discharging current=1A</p> 
<p>PV energy generated today and Load output energy today</p>	<p>PV energy generation today = 3.88kWh, Today load output energy= 9.88kWh.</p> 
<p>PV energy generated this month and Load output energy this month.</p>	<p>PV energy generation this month = 388kWh, Load output energy this month= 988kWh.</p> 
<p>PV energy generated this year and Load output energy this year.</p>	<p>PV energy generation this year = 3.88MWh, Load output energy this year = 9.88MWh.</p> 

<p>Total PV energy generation and total load output energy.</p>	<p>Total PV energy generation = 38.8MWh, Total load output energy = 98.8MWh.</p> 
<p>Real date.</p>	<p>Real date Nov 28, 2020.</p> 
<p>Real time.</p>	<p>Real time 13:20.</p> 
<p>Main CPU version checking.</p>	<p>Main CPU version 00014.04.</p> 
<p>Secondary CPU version checking.</p>	<p>Secondary CPU version 00003.03.</p> 
<p>Wi-Fi version checking.</p>	<p>Wi-Fi version 00000.24.</p> 

Operating Mode Description

Operation mode	Description	LCD display
<p>Standby mode</p> <p>Note:</p> <p>*Standby mode: The inverter is not turned on yet but at this time, the inverter can charge battery without AC output.</p>	<p>No output is supplied by the unit but it still can charge batteries.</p>	<p>Charging by utility and PV energy.</p> 
		<p>Charging by utility.</p> 
		<p>Charging by PV energy.</p> 
		<p>No charging.</p> 
<p>Fault mode</p> <p>Note:</p> <p>*Fault mode: Errors are caused by inside circuit error or external reasons such as over temperature, output short circuited and so on.</p>	<p>No charging at all no matter if grid or PV power is available.</p>	<p>Grid and PV power are available.</p> 
		<p>Grid is available.</p> 
		<p>PV power is available.</p> 
		<p>No charging.</p> 

Line Mode	The unit will provide output power from the mains. It will also charge the battery at line mode.	<p>Charging by utility and PV energy.</p> 
		<p>Charging by utility.</p> 
		<p>If "SUB" (solar first) is selected as output source priority and solar energy is not sufficient to provide the load, solar energy and the utility will provide the loads and charge the battery at the same time.</p> 
Line Mode	The unit will provide output power from the mains. It will also charge the battery at line mode.	<p>If either "SUB" (solar first) or "SBU" is selected as output source priority and battery is not connected, solar energy and the utility will provide the loads.</p> 
		<p>Power from utility.</p> 

<p>Battery Mode</p>	<p>The unit will provide output power from battery and/or PV power.</p>	<p>Power from battery and PV energy.</p> 
		<p>PV energy will supply power to the loads and charge battery at the same time. No utility is available.</p> 
		<p>Power from battery only.</p> 
		<p>Power from PV energy only.</p> 

Battery Equalization Description

Battery equalization function is built into the charge controller. It reverses the buildup of negative chemical effects such as stratification, a condition where acid concentration is greater at the bottom of the battery than at the top. Equalization also helps to remove sulfate crystals that may have built up on the plates. If left unchecked, this condition, called sulfation, will reduce the overall capacity of the battery. Therefore, it's recommended to equalize the battery periodically.

- **How to Activate Equalization Function**

You must enable battery equalization function in LCD setting Program 30 first. You can then apply this function by either one of the following methods:

1. Setting equalization interval in Program 35.
2. Activate equalization immediately in Program 36.

- **When to Equalize**

In floating charge stage, when setting the equalization interval (battery equalization cycle) is reached, or equalization is activated immediately, the controller will start to enter Equalize Mode.

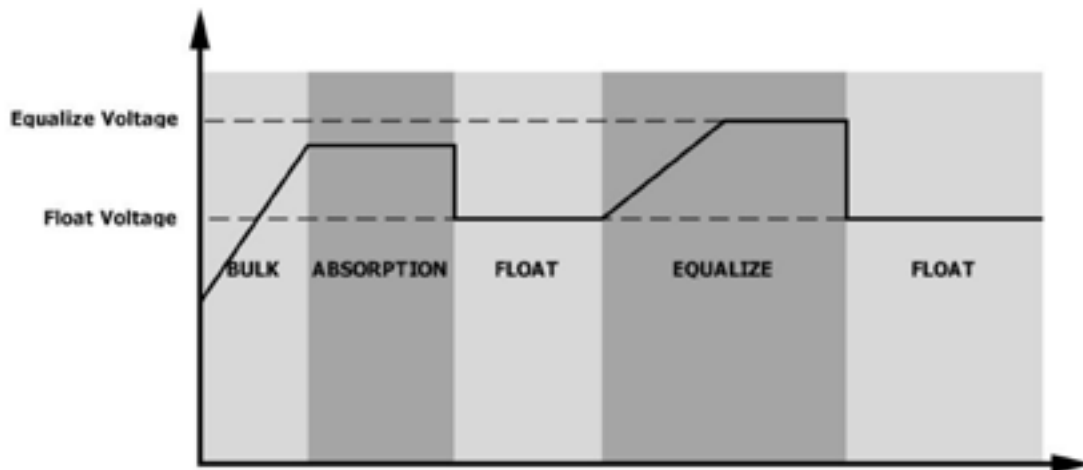

- **Equalize Charging and Timeout**

In Equalize Mode, the controller will supply power to charge battery as much as possible until battery voltage reach the equalization voltage. Then, constant-voltage regulation is applied to maintain battery voltage at the equalization level. The battery will remain in the Equalize Mode until the equalization timer runs out.

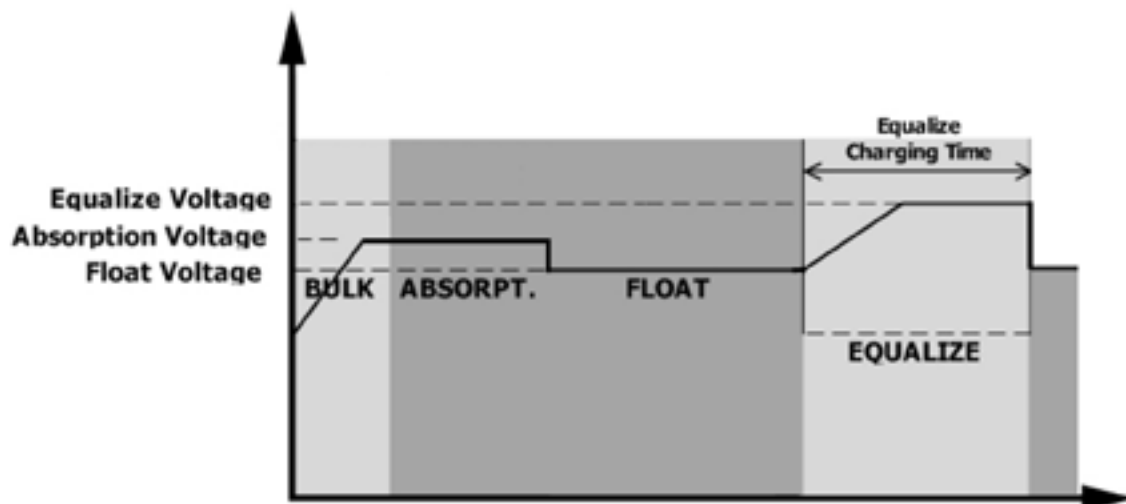



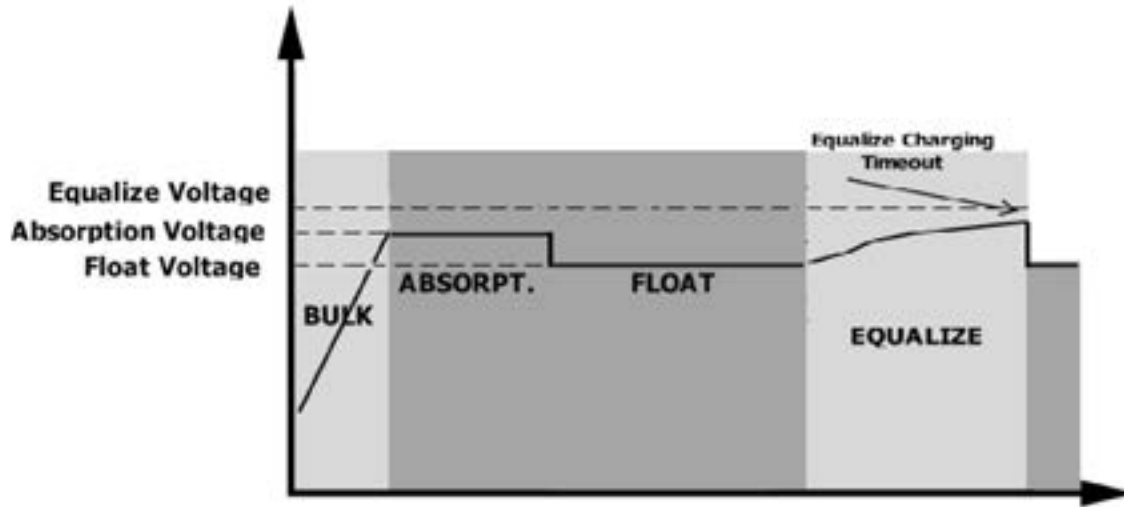









However, in Equalize Mode, if the battery equalization timer runs out and the battery voltage doesn't recover to the battery equalization voltage point, the charge controller will extend the battery equalized time until battery voltage achieves equalization voltage. If the battery voltage is still lower than equalization voltage when the extension runs out, the charge controller will stop equalization and return to the floating charging stage.



Fault Reference Code

Fault Code	Fault Event	Icon on
01	Fan is locked when inverter is off.	F01
02	Over temperature	F02
03	Battery voltage is too high	F03
04	Battery voltage is too low	F04
05	Output short circuited or over temperature is detected by internal converter components.	F05
06	Output voltage is too high.	F06
07	Overload time out	F07
08	Bus voltage is too high	F08
09	Bus soft start failed	F09
51	Over current or surge	F51
52	Bus voltage is too low	F52
53	Inverter soft start failed	F53
55	Over DC voltage in AC output	F55
57	Current sensor failed	F57
58	Output voltage is too low	F58
59	PV voltage is over limitation	F59

Warning Indicator

Warning Code	Warning Event	Audible Alarm	Icon flashing
01	Fan is locked when inverter is on.	Beep three times every second	01 
02	Over temperature	None	02 
03	Battery is over-charged	Beep once every second	03 
04	Low battery	Beep once every second	04 
07	Overload	Beep once every 0.5 second	07  
10	Output power derating	Beep twice every 3 seconds	10 
15	PV energy is low.	Beep twice every 3 seconds	15 
16	High AC input (>280VAC) during BUS soft start	None	16 
32	Communication failure between inverter and remote display panel	None	32 
E9	Battery equalization	None	E9 
bP	Battery is not connected	None	bP 

SPECIFICATIONS

Table 1 Line Mode Specifications

INVERTER MODEL	4KW	6KW
Input Voltage Waveform	Sinusoidal (utility or generator)	
Nominal Input Voltage	230Vac	
Low Loss Voltage	170Vac±7V (UPS); 90Vac±7V (Appliances)	
Low Loss Return Voltage	180Vac±7V (UPS); 100Vac±7V (Appliances)	
High Loss Voltage	280Vac±7V	
High Loss Return Voltage	270Vac±7V	
Max AC Input Voltage	300Vac	
Nominal Input Frequency	50Hz / 60Hz (Auto detection)	
Low Loss Frequency	40±1Hz	
Low Loss Return Frequency	42±1Hz	
High Loss Frequency	65±1Hz	
High Loss Return Frequency	63±1Hz	
Output Short Circuit Protection	Circuit Breaker	
Efficiency (Line Mode)	>95% (Rated R load, battery full charged)	
Transfer Time	10ms typical (UPS); 20ms typical (Appliances)	
<p>Output power derating: When AC input voltage drops to 170V, the output power will be derated.</p>		

Table 2 Inverter Mode Specifications

INVERTER MODEL	4KW	6KW
Rated Output Power	4KVA/4KW	6KVA/6KW
Output Voltage Waveform	Pure Sine Wave	
Output Voltage Regulation	230Vac±10%	
Output Frequency	50Hz	
Peak Efficiency	93%	
Overload Protection	5s@≥110% load; 10s@105%~110% load	
Surge Capacity	2* rated power for 5 seconds	
Max. AC Output Current	30Amp	40Amp
Nominal DC Input Voltage	24Vdc	48Vdc
Cold Start Voltage	23.0Vdc	46.0Vdc
Low DC Warning Voltage @ load < 50% @ load ≥ 50%	23.0Vdc 22.0Vdc	46.0Vdc 44.0Vdc
Low DC Warning Return Voltage @ load < 50% @ load ≥ 50%	23.5Vdc 23.0Vdc	47.0Vdc 46.0Vdc
Low DC Cut-off Voltage @ load < 50% @ load ≥ 50%	21.5Vdc 21.0Vdc	43.0Vdc 42.0Vdc
High DC Recovery Voltage	32Vdc	62Vdc
High DC Cut-off Voltage	33Vdc	63Vdc
No Load Power Consumption	<40W	<55W

Table 3 Charge Mode Specifications

Utility Charging Mode		
INVERTER MODEL	4KW	6KW
Charging Algorithm	3-Step	
AC Charging Current (Max)	100Amp (@V _{LLP} =230Vac)	
Bulk Charging Voltage	Flooded Battery	29.2Vdc
	AGM / Gel Battery	28.2Vdc
Floating Charging Voltage	27Vdc	54Vdc
Charging Curve	<p>The graph illustrates the charging process for a battery. The left y-axis represents Battery Voltage (V) per cell, ranging from 2.0V to 2.4V. The right y-axis represents Charging Current (%), ranging from 0% to 100%. The x-axis represents Time. The curve shows three distinct phases: 1. Bulk (Constant Current): The voltage rises linearly from approximately 2.0V to 2.3V while the current remains constant at 100%. 2. Absorption (Constant Voltage): The voltage remains constant at approximately 2.3V while the current gradually decreases. 3. Maintenance (Floating): The voltage drops slightly to approximately 2.25V and remains constant while the current continues to decrease towards 0%. The transition points between these phases are labeled T0 and T1. A note below the graph states: 'T0 = 20% SOI, maximum SOI, maximum SOC'.</p>	
MPPT Solar Charging Mode		
INVERTER MODEL	4KW	6KW
Max. PV Array Power	5000W	6000W
Max. PV Current	27A	
Nominal PV Voltage	320Vdc	360Vdc
Start-up Voltage	60Vdc +/- 10Vdc	
PV Array MPPT Voltage Range	60Vdc~450Vdc	
Max. PV Array Open Circuit Voltage	500Vdc	
Max Charging Current (AC charger plus solar charger)	120Amp	

Table 4 General Specifications

INVERTER MODEL	4KW	6KW
Operating Temperature Range	-10°C to 50°C	
Storage temperature	-15°C~ 60°C	
Humidity	5% to 95% Relative Humidity (Non-condensing)	
Dimension (D*W*H), mm	115 x 300 x 435	
Net Weight, kg	9	10

TROUBLE SHOOTING

Problem	LCD/LED/Buzzer	Explanation / Possible cause	What to do
Unit shuts down automatically during startup process.	LCD/LEDs and buzzer will be active for 3 seconds and then complete off.	The battery voltage is too low (<1.91V/Cell)	1. Re-charge battery. 2. Replace battery.
No response after power on.	No indication.	1. The battery voltage is far too low. (<1.4V/Cell) 2. Internal fuse tripped.	1. Contact repair center for replacing the fuse. 2. Re-charge battery. 3. Replace battery.
Mains exist but the unit works in battery mode.	Input voltage is displayed as 0 on the LCD and green LED is flashing.	Input protector is tripped	Check if AC breaker is tripped and AC wiring is connected well.
	Green LED is flashing.	Insufficient quality of AC power. (Shore or Generator)	1. Check if AC wires are too thin and/or too long. 2. Check if generator (if applied) is working well or if input voltage range setting is correct. (UPS→Appliance)
	Green LED is flashing.	Set "SUB" (solar first) as the priority of output source.	Change output source priority to "USB" (utility first).
When the unit is turned on, internal relay is switched on and off repeatedly.	LCD display and LEDs are flashing	Battery is disconnected.	Check if battery wires are connected well.
Buzzer beeps continuously and red LED is on.	Fault code 07	Overload error. The inverter is overload 110% and time is up.	Reduce the connected load by switching off some equipment.
		If PV input voltage is higher than specification, the output power will be derated. At this time, if connected loads is higher than derated output power, it will cause overload.	Reduce the number of PV modules in series or the connected load.
	Fault code 05	Output short circuited.	Check if wiring is connected well and remove abnormal load.
		Temperature of internal converter component is over 120°C.	Check whether the air flow of the unit is blocked or whether the ambient temperature is too high.
	Fault code 02	Internal temperature of inverter component is over 100°C.	
	Fault code 03	Battery is over-charged.	Return to repair center.
		The battery voltage is too high.	Check if spec and quantity of batteries are meet requirements.
	Fault code 01	Fan fault	Replace the fan.
	Fault code 06/58	Output abnormal (Inverter voltage below than 190Vac or is higher than 260Vac)	1. Reduce the connected load. 2. Return to repair center
	Fault code 08/09/53/57	Internal components failed.	Return to repair center.
	Fault code 51	Over current or surge.	Restart the unit, if the error happens again, please return to repair center.
	Fault code 52	Bus voltage is too low.	
Fault code 55	Output voltage is unbalanced.		
Fault code 59	PV input voltage is beyond the specification.	Reduce the number of PV modules in series.	

Appendix I: BMS Communication Installation

1. Introduction

If connecting to lithium battery, it is recommended to purchase a custom-made RJ45 communication cable. Please check with your dealer or integrator for details.

This custom-made RJ45 communication cable delivers information and signal between lithium battery and the inverter. These information are listed below:

- Re-configure charging voltage, charging current and battery discharge cut-off voltage according to the lithium battery parameters.
- Have the inverter start or stop charging according to the status of lithium battery.

2. Pin Assignment for BMS Communication Port

	Definition
PIN 1	RS232TX
PIN 2	RS232RX
PIN 3	RS485B
PIN 4	NC
PIN 5	RS485A
PIN 6	CANH
PIN 7	CANL
PIN 8	GND

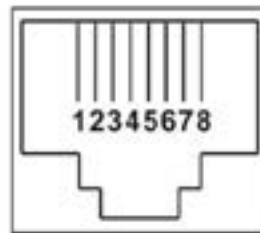

3. Lithium Battery Communication Configuration

LIO-4805/LIO-4810-150A

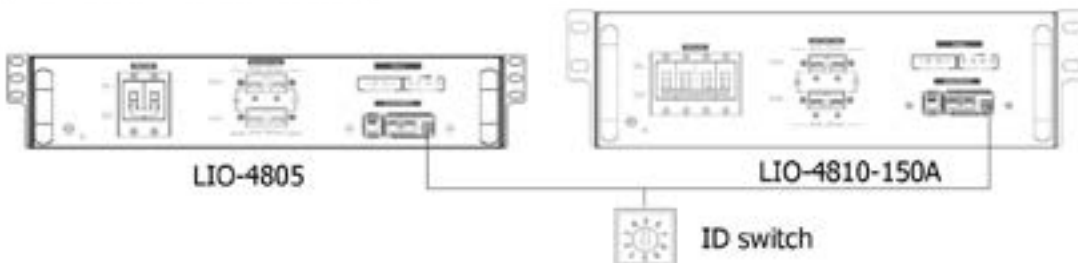

ESS LIO-I 4810

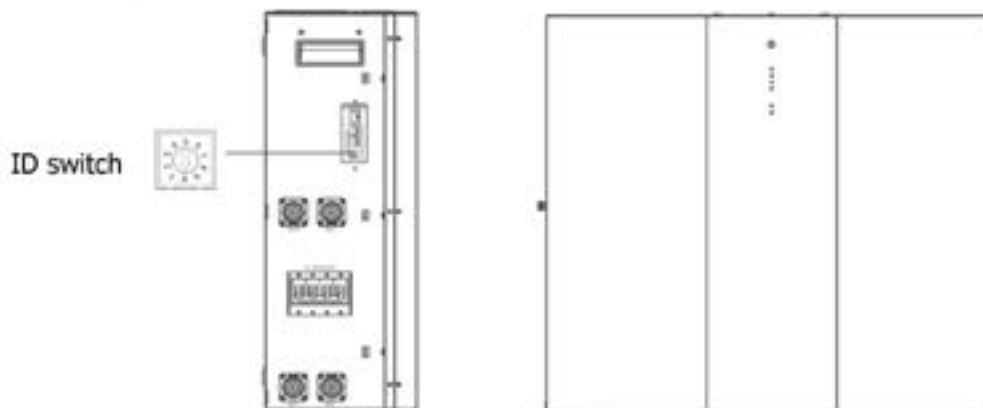

ID Switch indicates the unique ID code for each battery module. It's required to assign an identical ID to each battery module for normal operation. We can set up the ID code for each battery module by rotating the PIN number on the ID switch. From number 0 to 9, the number can be random; no particular order. Maximum 10 battery modules can be operated in parallel.

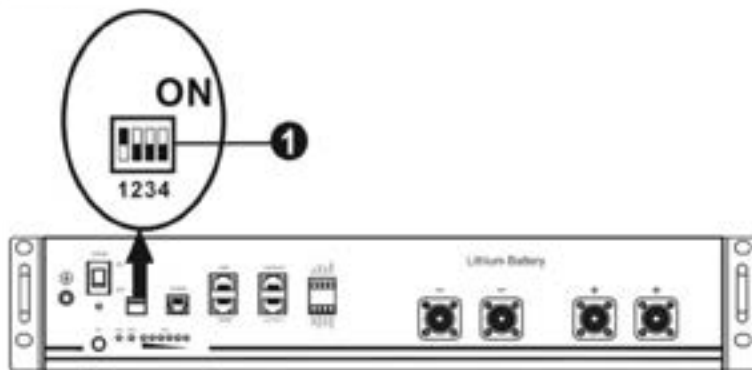

❶ Dip Switch: There are 4 Dip Switches that sets different baud rate and battery group address. If switch position is turned to the "OFF" position, it means "0". If switch position is turned to the "ON" position, it means "1".

Dip 1 is "ON" to represent the baud rate 9600.

Dip 2, 3 and 4 are reserved for battery group address.

Dip switch 2, 3 and 4 on master battery (first battery) are to set up or change the group address.

NOTE: "1" is upper position and "0" is bottom position.

Dip 1	Dip 2	Dip 3	Dip 4	Group address
1: RS485 baud rate=9600 Restart to take effect	0	0	0	Single group only. It's required to set up master battery with this setting and slave batteries are unrestricted.
	1	0	0	Multiple group condition. It's required to set up master battery on the first group with this setting and slave batteries are unrestricted.
	0	1	0	Multiple group condition. It's required to set up master battery on the second group with this setting and slave batteries are unrestricted.
	1	1	0	Multiple group condition. It's required to set up master battery on the third group with this setting and slave batteries are unrestricted.
	0	0	1	Multiple group condition. It's required to set up master battery on the fourth group with this setting and slave batteries are unrestricted.
	1	0	1	Multiple group condition. It's required to set up master battery on the fifth group with this setting and slave batteries are unrestricted.

NOTE: The maximum groups of lithium battery is 5 and for maximum number for each group, please check with battery manufacturer.

4. Installation and Operation

LIO-4805/LIO-4810-150A/ESS LIO-I 4810

After ID no. is assigned for each battery module, please set up LCD panel in inverter and install the wiring connection as following steps.

Step 1: Use supplied RJ11 signal cable to connect into the extension port (P1 or P2).

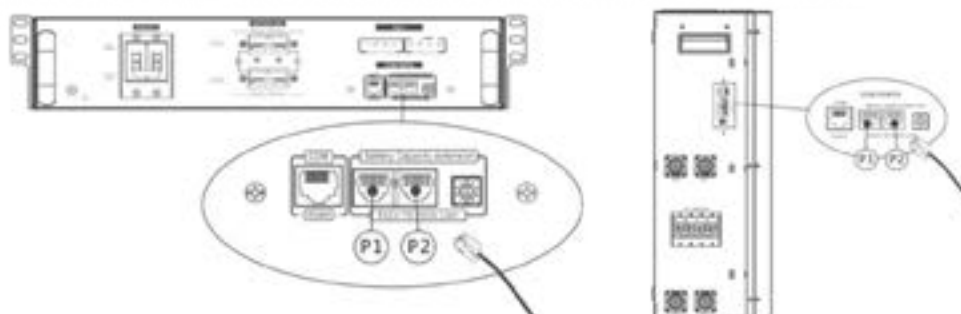

Step 2: Use supplied RJ45 cable (from battery module package) to connect inverter and Lithium battery.

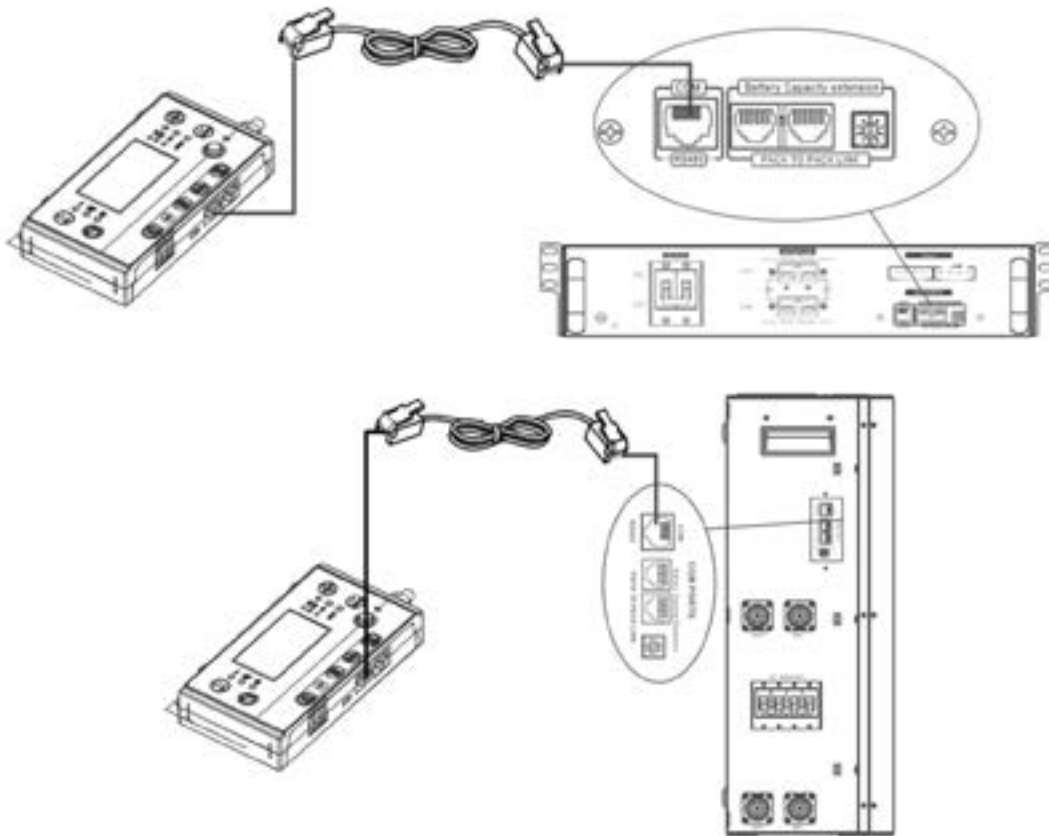

Note for parallel system:

1. Only support common battery installation.
2. Use custom-made RJ45 cable to connect any inverter (no need to connect to a specific inverter) and Lithium battery. Simply set this inverter battery type to "LIB" in LCD program 5. Others should be "USE".

Step 3: Turn the breaker switch "ON". Now, the battery module is ready for DC output.



Step 4: Press Power on/off button on battery module for 5 secs, the battery module will start up.

*If the manual button cannot be approached, just simply turn on the inverter module. The battery module will be automatically turned on.

Step 5. Turn on the inverter.



Step 6. Be sure to select battery type as "LIB" in LCD program 5.

05 

LIB



If communication between the inverter and battery is successful, the battery icon on LCD display will flash. Generally speaking, it will take longer than 1 minute to establish communication.

PYLONTECH

After configuration, please install LCD panel with inverter and Lithium battery with the following steps.

Step 1. Use custom-made RJ45 cable to connect inverter and Lithium battery.



Step 2. Switch on Lithium battery.

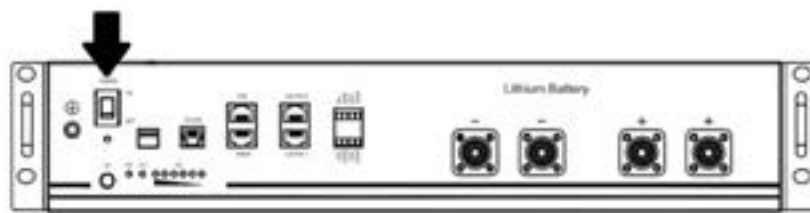

Step 3. Press more than three seconds to start Lithium battery. Output power is ready.

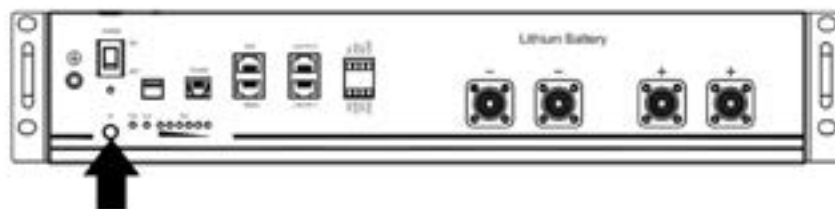

Step 4. Turn on the inverter.



Step 5. Be sure to select battery type as "PYL" in LCD program 5.

05 

PYL



If communication between the inverter and battery is successful, the battery icon on LCD display will flash. Generally speaking, it will take longer than 1 minute to establish communication.

Active Function

This function is to activate lithium battery automatically while commissioning. After battery wiring and commissioning is successfully, if battery is not detected, the inverter will automatically activate battery if the inverter is powered on.

WECO

Step 1. Use a custom-made RJ45 cable to connect inverter and Lithium battery.

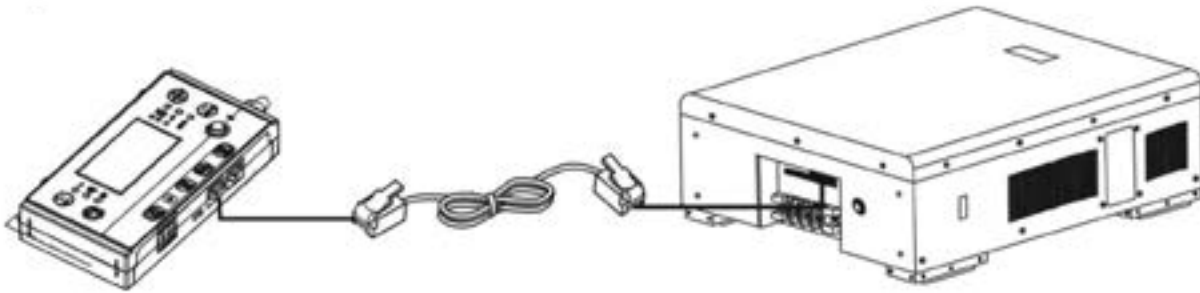

Step 2. Switch on Lithium battery.

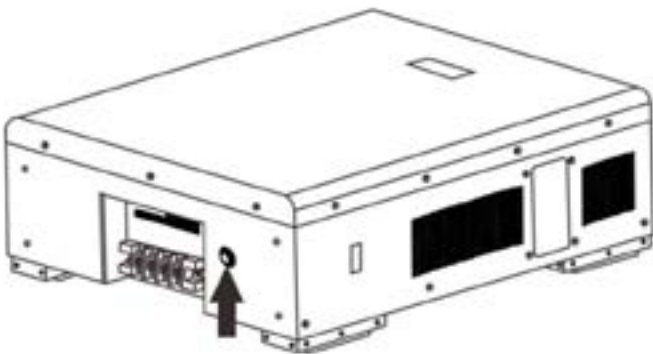

Step 3. Turn on the inverter.



Step 4. Be sure to select battery type as "WEC" in LCD program 5.



If communication between the inverter and battery is successful, the battery icon on LCD display will "flash". Generally speaking, it will take longer than 1 minute to establish communication.

SOLTARO

Step 1. Use a custom-made RJ45 cable to connect inverter and Lithium battery.

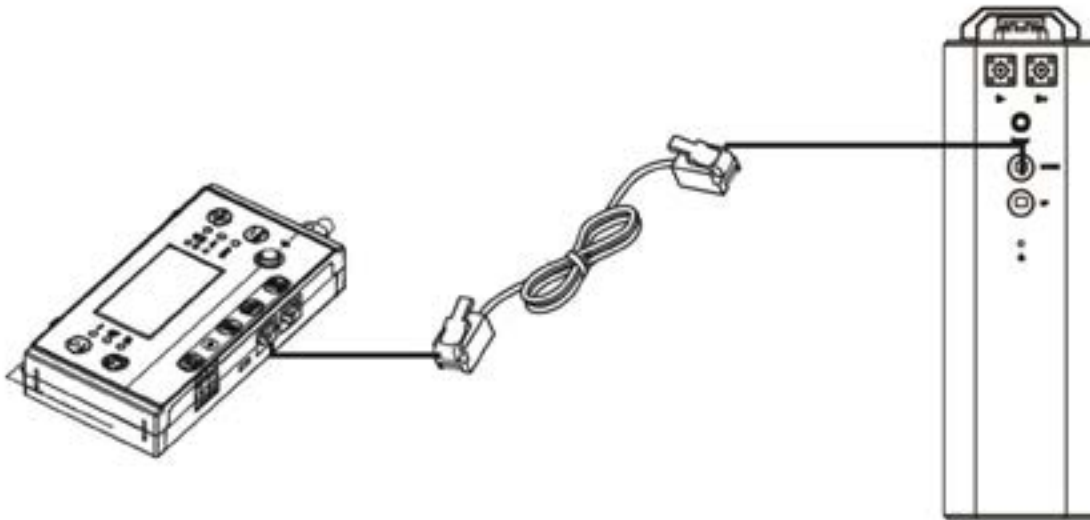

Step 2. Open DC isolator and switch on Lithium battery.

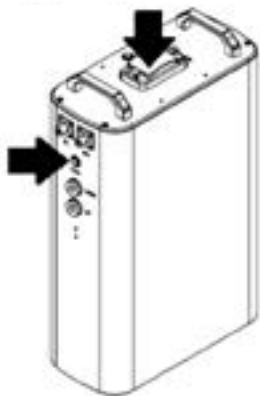

Step 3. Turn on the inverter.



Step 4. Be sure to select battery type as "SOL" in LCD program 5.

05 

SOL

If communication between the inverter and battery is successful, the battery icon  on LCD display will "flash". Generally speaking, it will take longer than 1 minute to establish communication.

5. LCD Display Information



Press "SELECT" button to switch LCD display information. It will show battery pack and battery group number before "Main CPU version checking" as shown below.

Selectable information	LCD display
Battery pack numbers & Battery group numbers	<p>Battery pack numbers = 3, battery group numbers = 1</p>

5. Code Reference

Related information code will be displayed on LCD screen. Please check inverter LCD screen for the operation.

Code	Description	Action
60	If battery status is not allowed to charge and discharge after the communication between the inverter and battery is successful, it will show code 60 to stop charging and discharging battery.	
61	<p>Communication lost (only available when the battery type is setting as any type of lithium-ion battery.)</p> <ul style="list-style-type: none"> After battery is connected, communication signal is not detected for 3 minutes, buzzer will beep. After 10 minutes, inverter will stop charging and discharging to lithium battery. Communication lost occurs after the inverter and battery is connected successfully, buzzer beeps immediately. 	
62	Battery number is changed. It probably is because of communication lost between battery packs.	<p>Press "UP" or "DOWN" key to switch LCD display until below screen shows. It will have battery number re-checked and 62 warning code will be clear.</p>
69	If battery status is not allowed to charge after the communication between the inverter and battery is successful, it will show code 69 to stop charging battery.	
70	If battery status must to be charged after the communication between the inverter and battery is successful, it will show code 70 to charge battery.	
71	If battery status is not allowed to discharge after the communication between the inverter and battery is successful, it will show code 71 to stop discharging battery.	

Appendix II: The Wi-Fi Operation Guide

1. Introduction

Wi-Fi module can enable wireless communication between off-grid inverters and monitoring platform. Users have complete and remote monitoring and controlling experience for inverters when combining Wi-Fi module with WatchPower APP, available for both iOS and Android based device. All data loggers and parameters are saved in iCloud.

The major functions of this APP:

- Delivers device status during normal operation.
- Allows to configure device setting after installation.
- Notifies users when a warning or alarm occurs.
- Allows users to query inverter history data.



Document version	Modifications	Moderator	Date	Remarks
1.0	First Edition	Silver	2023-04-24	
1.1	Add WIFI distribution instructions	Silver	2024-01-17	

Preface

Users can configure Wi-Fi for our inverter devices through the local Wi-Fi configuration function of Smart Life APP, and check the information about the devices and their connected devices. The inverter clock is calibrated when the module is connected to the network.

1. Download and login Smart Life APP

Users adding devices need to open the Bluetooth function to connect the device and open the wifi function to let the software get the current WiFi parameters, if the software can not automatically get the wifi parameters, please follow the prompts to fill in the connected WiFi parameters:

QR code download address:



Smart Life APP

APP login:



Registration and Login Page

2. Follow the prompts to add a device

To add a module, users need to open the Bluetooth function to connect the module and open the wifi function to let the software get the current WiFi parameters, if the software can't get the wifi parameters automatically, please follow the prompts to fill in the wifi parameters of the module connection in the corresponding page.

When the module connects to WIFI for the first time, you cannot configure WIFI for the module until the inverter has been switched on for ten seconds, and the time to configure WiFi is three minutes. It must be ensured that the inverter is completely powered off for five seconds before rebooting, otherwise the module cannot enter WIFI configuration mode.

After the module is connected, the module will not be found by other devices, if you need to add devices to other accounts, please close the module currently connected to the wifi and restart the module, after ten seconds of restart the module can not be connected to the previous wifi will enter the wifi configuration mode, it can be found by other devices and add, the module can be added to multiple accounts.



1.Adding modules

2.Discovery module

3.Fill in wifi information

4.Finish

3. Module Software Home

On the home page, the user can see the inverter operating mode, the inverter serial number, as well as the entry for grid, PV, battery, load, data and warning information, and click on the corresponding graph to view the corresponding information.



4. Grid, PV, battery, load, data and warning messages

The information available for viewing is shown below:

